

Laboratory Planning Solutions®



Lab Spaces

Most extensive lineup of
Laboratory furniture equipment



- ✓ **UniLine Laboratory Furniture**
- ✓ **NEW UniFlow Laboratory Fume Hoods**
- ✓ **Lab Tables & Worksurfaces**
- ✓ **Canopy Hoods**
- ✓ **Emergency Showers**

*Acid & Flammable
Storage Cabinets*



HEMCO®

Laboratory Planning Solutions

www.HEMCOcorp.com

Call: 816-796-2900



Welcome to HEMCO®

HEMCO a leading manufacturer of innovative laboratory equipment serving the Sciences and R&D Technology Industries since 1958.

Located in Independence, Missouri, the heart of America and the crossroads of North America a major center for transportation, communication, distribution, and manufacturing industries worldwide.

HEMCO's modern manufacturing and distribution facilities combined with our extensive engineering, design, and manufacturing capabilities are the solution for your Laboratory Planning requirements.

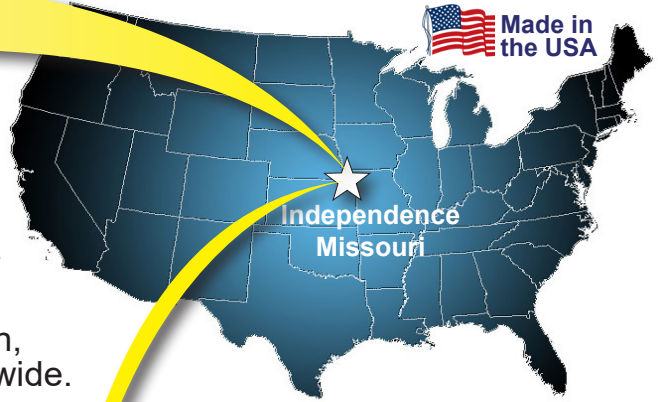

Scan the Code to Visit
www.HEMCOcorp.com



World Wide Partners and Clients

• Asia

• North America

• Europe



• Australia

• South America

• Africa

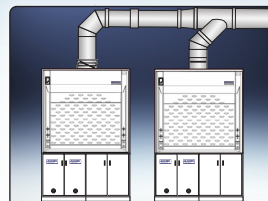

Call 816-796-2900

Email: info@hemcocorp.com

Visit: www.HEMCOcorp.com

Laboratory Planning Solutions



Table of Contents

Welcome to HEMCO.....2

Section I: Laboratory Furniture Tops & Services

Plan A Lab / Casework Construction.....4

UniLine Furniture Groupings.....5-7

UniLine Base Cabinets.....8

Laboratory Cabinets & Accessories.....9

Acid Storage Cabinets.....10

Flammable Storage Cabinets.....11

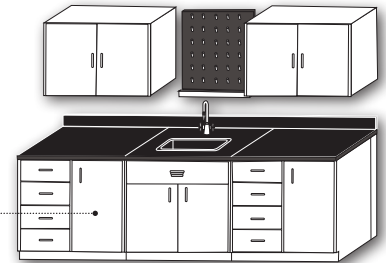

Section II: Fume Hoods & Accessories

Lab Tops & Sinks.....12

Plumbing, Electrical, & Safety.....13

UniFlow SL Fume Hood.....14-15

Plan-A-Hood SL16

Fume Hood Plumbing Fixtures.....17

Fume Hood Electrical Services.....18

Fume Hood Sinks & Plumbing.....19

Apparatus Grids & Fire Extinguishers.....20

Chemical Resistance.....21

Tables/Mobile Tables.....22

Worksurfaces.....23

Energy Savings Recommendations.....24

Ventilation & Duct Design.....25

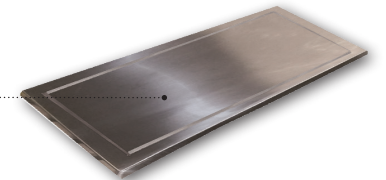

Section III: Safety Equipment

Canopy Hoods.....26

Emergency Showers.....27



HEMCO Plan-A-Lab Worksheet showing Groupings

The HEMCO Plan-A-Lab enables you to conveniently lay out your lab furniture and your pre-engineered modular clean lab. For more information request the Modular Clean Room Brochure. Shown below is a 20' X 24' (2) wall system. Existing walls in black, new walls in yellow slash mark.

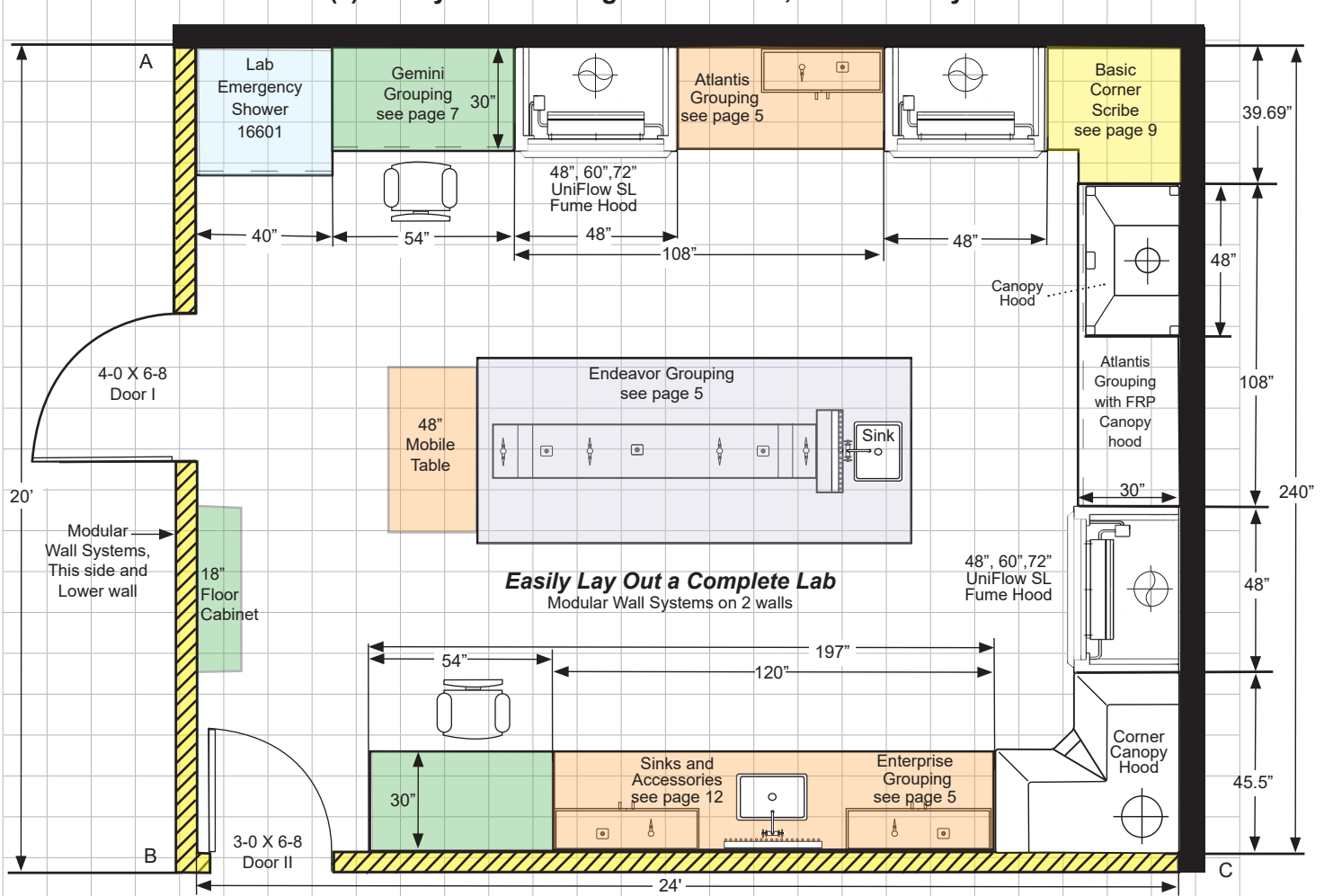

For Lab Planning worksheet visit: www.hemcocorp.com/images/Literature/PlanALab.pdf shown above 20' X 24' (2) wall system

UniLine Laboratory Casework Construction (SEFA 8 Compliant)



UniLine Casework is constructed of welded 18 gauge steel. Powder coat finish is environment friendly, attractive and long lasting, color: Lab White. Modular design allows for simple field conversion from inlet to overlay, door and drawer re-configurations and hardware component changes. Casework is tested independently to be SEFA 8 load bearing capacity compliant.



worksurface page 12



Rear Filler Panel
Cat. No. 74112

48" Cabinet
Cat. No. 71064
epoxy, stainless steel and phenolic worksurfaces available

Recessed Toe Space promotes laboratory cleanliness. Cabinet base lower corner reinforcing gusset with 0 to 2-1/2" zinc leveling bolts on (all four corners). Cabinet height adjustable from 35" to 37". 12 gauge steel corner gusset (4) each cabinet.

Drawer Bodies constructed of 20 gauge steel. 18 gauge drawer suspension with full extension ball bearing drawer slide. File drawer suspension available in both 100 and 150 lb capacity. Exterior is urethane powder coated steel, for chemical and abrasion resistance.

Doors double wall construction with 20 gauge reinforcing channel (1) per door. Rubber door bumpers (4) per door. Five knuckle hinges (2) per door. Nylon roller catch (1) per door. Urethane powder coated steel. Manual, self closing.

Cabinet Interior Full length & width adjustable 20 gauge steel shelf for maximum Storage. Zinc plated adjustable steel shelf clips. Powder coated finish for chemical resistance. 18 gauge full height removable access panel. Color: Lab White

Laboratory Furniture Groupings

UniLine design incorporates our most popular casework groupings to meet your laboratory needs. Welded steel with chemical resistant, epoxy powder coat finish, and 1" thick phenolic resin countertops, 4" high backsplashes, and flush ends standard. Standard height 36", ADA height 34", and sitting height 28" options are available. Standard color: Lab White. (optional colors are available as required) Groupings can be supplied with optional Fume hoods.

Atlantis Grouping

Atlantis Grouping provides basic lab Storage & a versatile work area. Cabinet grouping includes 3 standing height cabinets with rear filler panels on both ends, phenolic resin worksurface with 4" high back splash. Includes 16" X 12" X 8" sink and H/C gooseneck faucet.

Atlantis Cabinet Grouping

Width	1	2	3	24" Depth Cat. No.	30" Depth Cat. No.
108"	36"	36"	36"	70011	70021
120"	36"	48"	36"	70012	70022
144"	48"	48"	48"	70013	70023

Enterprise Grouping

Enterprise Grouping provides a convenient balance of Storage and work space. Cabinet grouping includes 3 standing height cabinets with rear filler panels, 2 wall cabinets, phenolic resin worksurface with 4" high back splash. Includes 16" X 12" X 8" sink, 30" X 30" pegboard and H/C gooseneck faucet.

Enterprise Cabinet Grouping

Width	1	2	3	24" Depth Cat. No.	30" Depth Cat. No.
108"	36"	36"	36"	70211	70221
120"	36"	48"	36"	70212	70222
144"	48"	48"	48"	70213	70223

Endeavour Island Grouping

Endeavour Grouping is a flexible design that can serve as an island or peninsula layout. Cabinet grouping includes either 3 or 7 standing height cabinets with front and end filler panels, phenolic resin worksurface, and center island reagent shelf with pedestals and phenolic resin shelf. Includes 16" X 12" X 8" sink, 30" X 30" pegboard and H/C gooseneck faucet.

Endeavor Cabinet Grouping

Width	1	2	3	4	Cat. No.
101"	36"	36"	—	60"	71311
137"	36"	36"	36"	60"	71312
173"	48"	48"	48"	60"	71313

Viking/Magellan Grouping

Viking Grouping is ideal for medical examination rooms and small lab requirements. Cabinet grouping includes 1 or 2 standing height cabinets, 1 wall cabinet 36" or 48" wide, 24" high 12" deep, phenolic resin worksurface. Includes 16" X 12" X 8" sink and H/C gooseneck faucet.

Viking Cabinet Grouping

Width	1	2	24" Depth Cat. No.	30" Depth Cat. No.
72"	36"	36"	70413	70423
96"	48"	48"	70414	70424

Magellan Sink Cabinet Grouping

Width	1	24" Depth Cat. No.	30" Depth Cat. No.
36"	36"	70611	70621
48"	48"	70612	70622

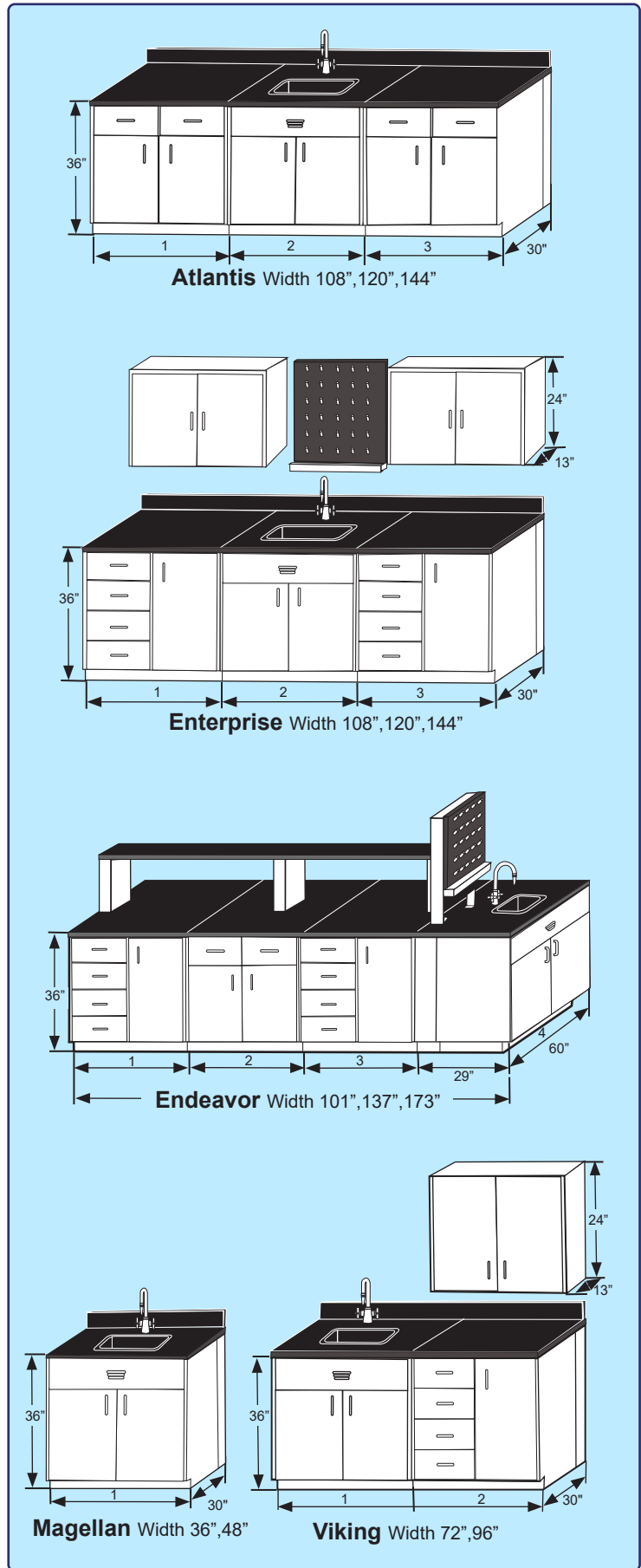

UniLine Furniture Groupings

Unitized design incorporates our most popular casework groupings to meet your laboratory needs. Welded steel with chemical resistant, epoxy powder coat finish, and 1" thick phenolic resin worksurface, 4" high backsplashes, and flush ends standard. ADA height 34" Max, and sitting height 28", options are available. Standard color: Lab White (optional colors are available as required)

Artemis Grouping

UniLine Artemis Grouping provides ample lab Storage with options. Cabinet grouping includes (3) 36" high cabinets, phenolic resin worksurface, with 4" high back splash. Includes 16" X 12" X 8" sink and H/C gooseneck faucet, and three wall cabinets. Add a UniFlow SL fume hood in widths of 48", 60", 72", and 96" wide see page 15.

Artemis Cabinet Grouping					
Cat.No.	Length	1	2	Add a hood Select 48", 60", 72" or 96" SL see page 15	
70901	108"	36"	36"	36"	
70902	144"	48"	48"	48"	

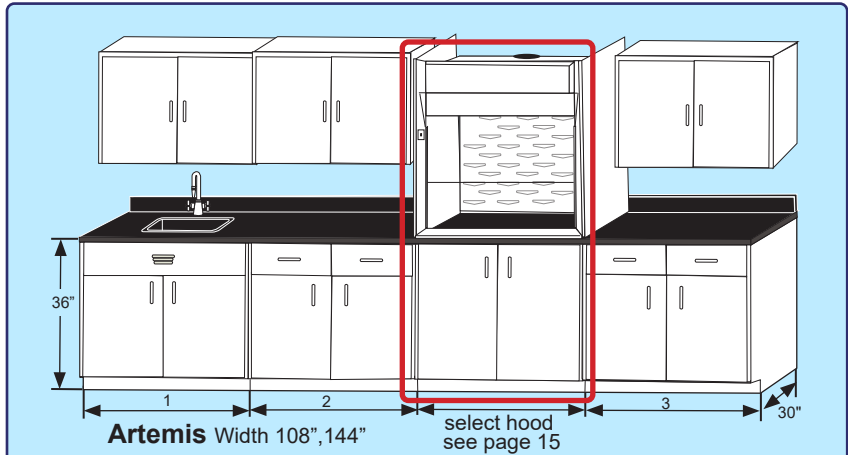

Ranger Grouping

UniLine Ranger Grouping combines convenient basic lab Storage. Grouping includes (3) 36" high cabinets with rear filler panels on both ends, phenolic resin worksurface with 4" high back splash. Add a UniFlow SL fume hood in widths of 48", 60", 72", and 96" wide see page 15.

Ranger Cabinet Grouping						
Cat.No.	Length	1	Add a hood Select 48", 60", 72" or 96" SL see page 15		2	3
70911	108"	36"	36"		36"	36"
70912	144"	48"	48"		48"	48"

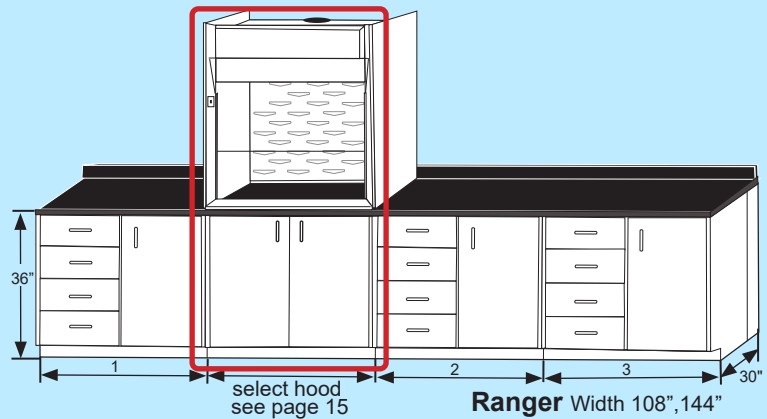

Surveyor Grouping

UniLine Surveyor Grouping accommodates greater Storage requirements. Grouping includes (3) cabinets 36" high, phenolic resin worksurface with 4" high backsplash, 16" X 12" X 8" sink, H/C gooseneck faucet and pegboard. Add a UniFlow SL fume hood in widths of 48", 60", 72", and 96" wide see page 15.

Surveyor Cabinet Grouping						
Cat.No.	Length	1	2	3	Add a hood Select 48", 60", 72" or 96" SL see page 15	
70921	108"	36"	36"	36"	36"	
70922	144"	48"	48"	48"	48"	

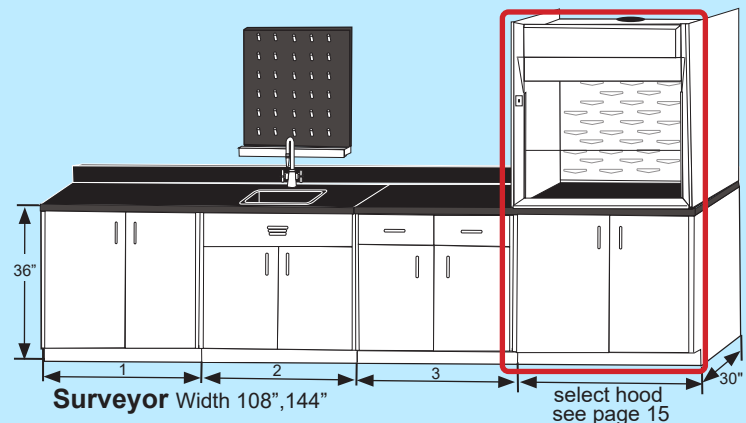

Lunar Grouping

UniLine Lunar Grouping provides lab Storage. Cabinet grouping includes (3) 36" high cabinets with rear filler panels on the ends, and one floor Storage cabinet, phenolic resin worksurface with 4" high back splash. Includes two wall cabinets. Add a UniFlow SL fume hood in widths of 48", 60", 72", and 96" wide see page 15.

Lunar Cabinet Grouping							
Cat.No.	Length	Add a hood Select 48", 60", 72" or 96" SL see page 15			1	2	3
70931	108"	36"			36"	36"	36"
70932	144"	48"			48"	48"	48"

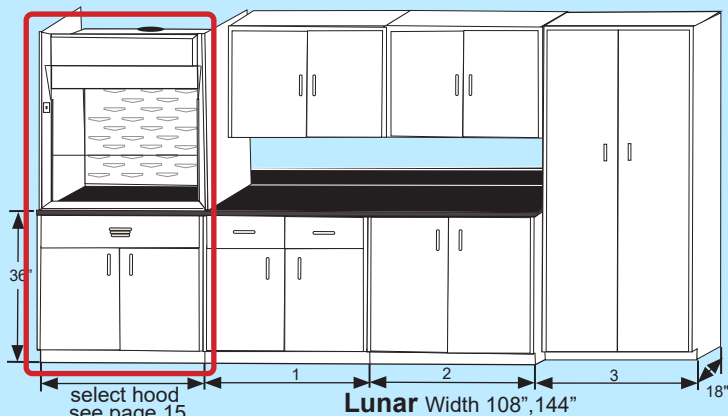

UniLine Furniture Groupings

Unitized design incorporates our most popular casework groupings to meet your laboratory needs. Welded steel with chemical resistant, epoxy powder coat finish, and 1" thick phenolic resin worksurface, 4" high backsplashes, and flush ends standard. ADA and sitting height options are available. Standard color: Lab White (optional colors are available as required)

Gemini Grouping

UniLine Gemini grouping features a sitting height desk area that can be incorporated with any of the HEMCO groupings. Cabinet grouping includes one sitting height file drawer cabinet with knee space panel, single apron, and phenolic resin worksurface. Sitting height 28".

Length	1	2	24" Depth Cat. No.	30" Depth Cat. No.
48"	30"	18"	70501	70521
54"	36"	18"	70502	70522
66"	48"	18"	70503	70523

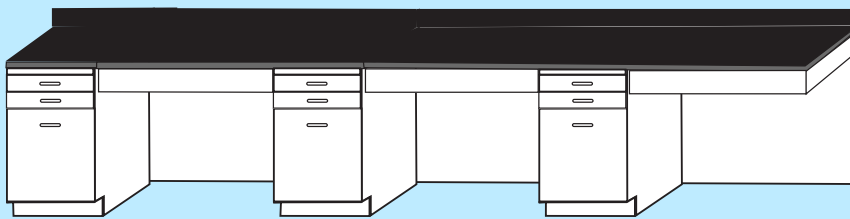

Example of (3) Gemini Groupings

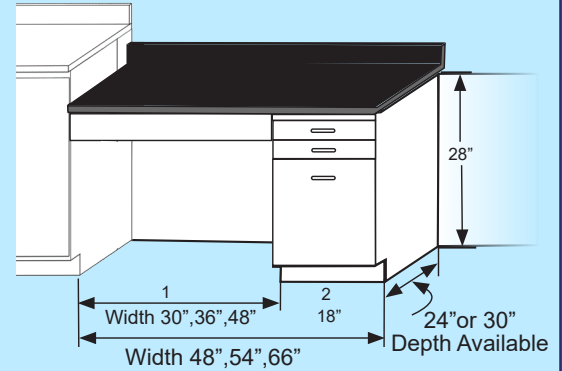

ADA

Freedom (ADA) Grouping Option

When ADA requirements are necessary, the UniLine Freedom Grouping option allows you specify any HEMCO casework grouping and be compliant to all dimension, space, and access standards as specified by ADA. In addition, all electrical services, plumbing accessories and safety equipment including emergency showers and eye wash stations are designed to meet ADA guidelines. Counter top height is 34". For ADA recommended reach see diagram 1 and 2.

Simply add "ADA" as a suffix to any HEMCO part number and HEMCO can design, quote, and supply ADA compliant equipment. Proper planning eliminates/reduces future problems. For a complete guide for all ADA technical information, including dimensions and standards, please visit: www.access-board.gov.

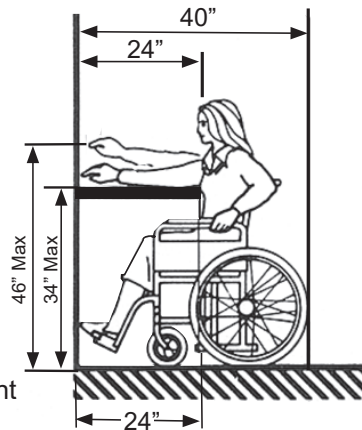

Diagram #1
Reach In

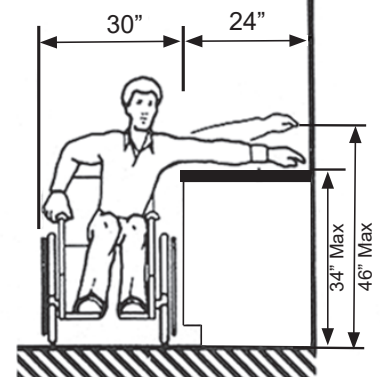
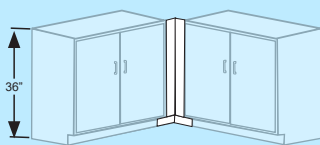

Diagram #2
Reach Over

Corner Grouping Solutions

HEMCO corner cabinets and fillers offer several means by which casework groupings or individual cabinets can be connected at a corner, eliminating unused corner space.



Basic Corner Scribe with worksurface
2" Cat. No. 74002

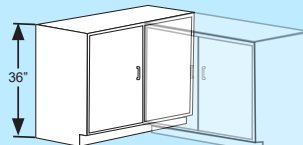

Overlap Corner Cabinet
36" Cat. No. 71981
48" Cat. No. 71983

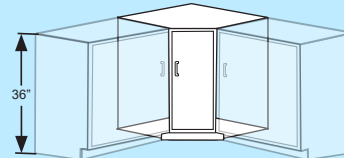

Spacious Corner Cabinet with worksurface
Cat. No. 71901

Corner Canopy



Corner Canopy Hoods

UniLine Base Cabinets

Lab cabinets are offered in standard modular sizes that allow you to create a custom laboratory to meet your specific needs. Cabinets feature furniture grade welded steel construction with a durable, chemical resistant, epoxy powder coat finish that meet or exceed SEFA 8, recommended practice for laboratory casework. Standard color: Lab White (optional colors are available as required) (Available in Stainless Steel or Polypro) (and ADA heights).

Base Cabinets (cabinets in boxes are in stock)

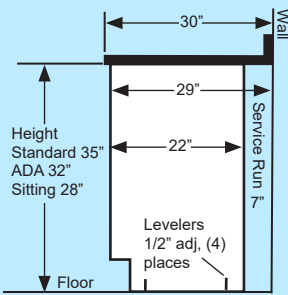

Cabinet End View

3 Drawer

Width	Cat. No.
18"	70701
24"	70702

For Gemini Groupings

4 Drawer

Width	Cat. No.
18"	71221
24"	71222

1 Drawer - 1 Door

Width	Cat. No.
18"	71181
24"	71182

Specify left or right hinged

1 Door

Width	Cat. No.
18"	71951
24"	71952

Specify left or right hinged

2 Drawer - 2 Door

Width	Cat. No.
30"	71061
36"	71062
48"	71064

1 Drawer - 2 Door

Width	Cat. No.
30"	71051
36"	71052
48"	71054

5 Drawer - 1 Door

Width	Cat. No.
30"	71131
36"	71132
48"	71134

4 Drawer - 1 Door

Width	Cat. No.
30"	71101
36"	71102
48"	71104

optional Acid Cabinet on door side

4 Drawer - 2 Door

Width	Cat. No.
30"	71081
36"	71082
48"	71084

5 Drawer

Width	Cat. No.
30"	71231
36"	71232
48"	71234

8 Drawer

Width	Cat. No.
30"	71241
36"	71242
48"	71244

6 Drawer

Width	Cat. No.
30"	71381
36"	71382
48"	71384

4 Drawer

Width	Cat. No.
30"	71211
36"	71212
48"	71214

Vacuum Cabinet

Width	Cat. No.
30"	71821
36"	71822
48"	71824

Base Cabinet

Width	Doors	Cat. No.
24"	1	52411
30"	2	53011
36"	2	53611
48"	2	54811
60"	2	56011

Acid Cabinet
(see page 12)

Width	Doors	Cat. No.
24"	1	15240
30"	2	15300
36"	2	15360
48"	2	15480
Vent Kit	---	81000

Flammable Cabinet

Width	Cat. No.
24"	18020
30"	18300
36"	18030
48"	18040
Vent Kit	81000

Sink Unit Cabinet

Width	Cat. No.
24"	71810
30"	71811
36"	71812
48"	71814
60"	71815

Sink End Unit

Width	Cat. No.
52"	71881
58"	71882

Wall Cabinets, Floor Cabinets, and Accessories

Wall Cabinets

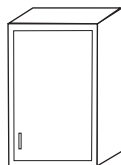

Single Door Wall Cabinet

Width	Height	Depth	Cat. No.
18"	30"	13"	72171
24"	30"	13"	72172
Specify left or right hinged			

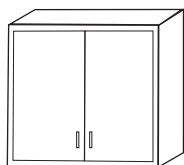

2 Door Wall Cabinet

Width	Height	Depth	Cat. No.
30"	30"	13"	72031
36"	30"	13"	72032
48"	30"	13"	72034

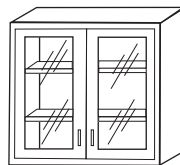

2 Door Framed Glass Cabinet

Width	Height	Depth	Cat. No.
30"	30"	13"	72061
36"	30"	13"	72062
48"	30"	13"	72064

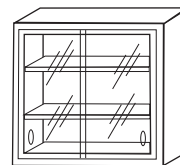

2 Glass Sliding Door Cabinet

Width	Height	Depth	Cat. No.
30"	30"	13"	72191
36"	30"	13"	72192
48"	30"	13"	72194

Floor Mounted Cabinets (Standard color: Lab White)

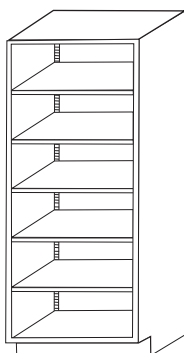

Floor Cabinet Open Front

Storage cabinet with 5 adjustable shelves. Height 84", Depth 18"

Width	Cat. No.
30"	73381
36"	73382
48"	73384

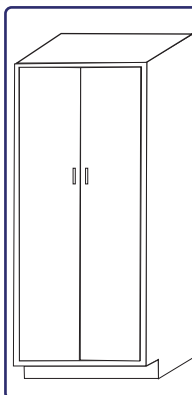

Floor Cabinet Solid Hinge Door

Storage cabinet with 5 adjustable shelves. Height 84", Depth 18"

Width	Cat. No.
30"	73321
36"	73322
48"	73324

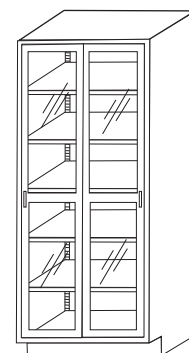

Floor Cabinet Slide Glass Door

Storage cabinet has glazed 1/4" glass doors and 5 adjustable shelves. Height 84", Depth 18"

Width	Cat. No.
30"	73371
36"	73372
48"	73374

Casework Accessories (Standard color: Lab White)

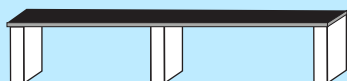

Reagent Shelf

Shelves are 4" wide 12" deep and 16" high. For use on island, peninsula, or against wall. Phenolic Resin shelf is 1" thick & 14" deep

Length	Cat. No.
6'	75111
9'	75112
12'	75113



Single Drawer Apron

4 1/2" high. Used to span knee space area and support countertop.

Width	Depth	Cat. No.
30"	22"	74031
36"	22"	74032
48"	22"	74034



Wall Shelf

8" deep. Includes vertical flanges for mounting.

Width	Cat. No.
24"	75911
30"	75912
36"	75913
48"	75914

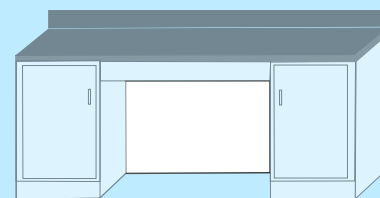

Knee Space Panel

35" high. Located at the rear of knee space areas.

Width	Cat. No.
24" to 36"	73261
36" to 48"	73262
54" to 66"	73263



End Panel

35" high x 22" or 28" deep. Used to support countertops at the end or middle of a knee space area. Please specify depth.

Cat. No. 73255

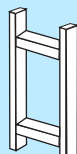

Leg Assembly

35" high x 22" or 28" deep. Used to support countertops at the end or middle of a knee space area. Please specify depth.

Cat. No. 73355



Front Rail

2" high x 30", 36" or 48" wide. Used to support countertops above knee space areas. Please specify width.

Cat. No. 74015



Cabinet Lock

Five-Disc tumbler door & drawer cam lock & (2) keys.

Cat. No. 75001



Utility Chase

24" wide x 6" deep x 84" high. Located on an island behind a sink. Used to conceal piping and to serve as mounting for pegboard.

Cat. No. 75091

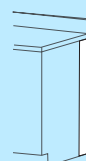

Rear Filler Panel

35" high x 7" wide. Used to enclose pipe chase behind cabinets on standard 30" deep counters.

Cat. No. 74112

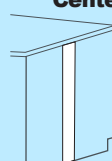

Center Filler Panel

35" high x 4", 10", or 14" wide. Used to enclose the pipe chase at the end of an island. Please specify width.

Cat. No. 74122

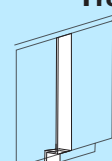

Front Filler Panel

35" high x 2", 6", or 12" wide. Used to enclose the space between cabinets to meet casework length requirement. Please specify width.

Cat. No. 74142

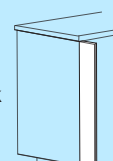

End Scribe

35" high x 2", 6", or 12" wide. Used to fill the space between the end of casework and a wall. Please specify width.

Cat. No. 74001

UniLine ACID Storage Cabinets



- Molded one piece chemical and acid resistant, composite liner, molded one-piece covered corners, glass smooth for ease of cleaning
- Cabinet Exhaust can be vented out the back or through the fume hood or through an exhaust blower system
- Removable rear panel allows access to connect venting
- Removable Shelf for small container Storage
- Front Access doors are lined and edges are sealed
- Door Vents provide Supply air ventilation
- Removable containment tray
- Containment Lip on front bottom edge of cabinet to hold spills

For Storage of ACID and corrosive chemicals, available in 12", 18", 24", 30", 36", 42" & 48" widths. Standard 35 1/4" high and 22" deep cabinet dimension. (as shown) U.L. 1805 Fume Hoods & Cabinets. Cabinets are designed to hold specific chemicals



Acid Storage Containment Tray to contain large spills and provides ease of cleanup. (located in bottom of cabinet)



12", 18", 24" widths

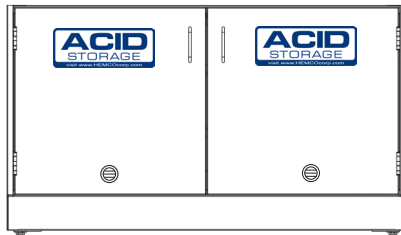

30", 36", 42", 48" widths

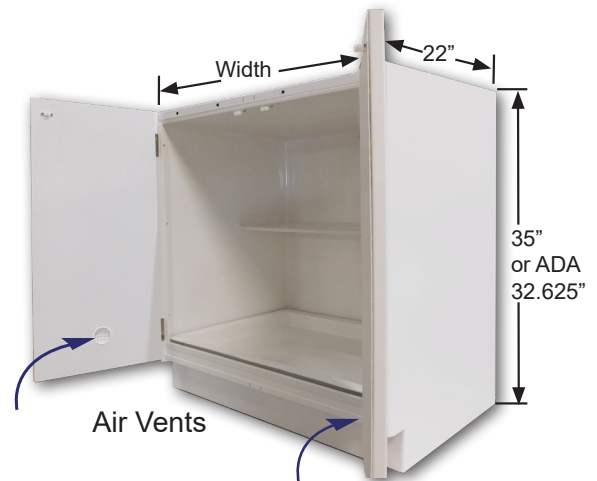

Acid Cabinet Size							
Width	12"	18"	24"	30"	36"	42"	48"
35 1/4" high X 22" deep	15120	15180	15240	15300	15360	15420	15480

Venting Your Acid Cabinet (select 1 or 2)

① Acid Cabinet Vent Through Fume Hood Double Side Wall & worksurface

(1) 90 Degree Elbow
(1) Vent outlet Exhaust Vent Kit
Cat. No. 81001

② Acid Cabinet Exhaust Blower through the wall

(1) 90 Degree Elbow Exhaust
(1) 10' Ridge & Flex
(1) Exhaust Blower Vent Outlet
Cat. No. 81002

Liquid Chemical Storage Cabinets shall be in an area of the laboratory with low traffic away from the main work area. It is important to segregate incompatible chemicals. Eliminate ignition sources such as open flame, hot surfaces, electrical equipment or static electricity from the Storage area. Make sure appropriate fire extinguishers and/or sprinkler systems are in the area. An eyewash and safety shower must be readily accessible to areas where liquid chemicals are stored, per OSHA 1910.106(d)(3)(I).

Note: Venting voids the U.L. listing, If applicable, as site conditions cannot be verified by U.L.

Flammable Storage Cabinets



- Doors One-piece double wall construction painted before assembly. Insulated door filler for added rigidity and quiet operation. Rubber door bumpers. Powder coated finish.
- Cabinet Exhaust can be vented out the back or through the fume hood or through a exhaust blower system
- Removable Shelf for small container Storage
- Cabinet interior bottom with a radius flange for increased strength and ease of cleaning.
- Containment Lip on front bottom edge of cabinet to hold spills
- Mobile Cabinets are available.

For Storage of Flammable chemicals, available in 18", 24", 30", 36" & 48" widths. Standard 35 1/4" high and 22" deep cabinet dimension. (as shown) U.L. 1805 Fume Hoods & Cabinets

- Solvent Storage Cabinets are specifically designed for the Storage of flammable and combustible liquids.
- Construction meets the requirements listed by UFC, OSHA and NFPA No. 30-1993 and are UL listed.
- A 2" deep liquid-tight pan covers the entire bottom of the cabinet to contain liquid leaks and spills. Two diametrically opposed vents with spark screens are provided in the back of the cabinet as well as a grounding screw.
- Cabinets are labeled: **FLAMMABLE - KEEP FIRE AWAY**
- The right hand door is equipped with a three-point latching system.



Rear view with connections for venting.

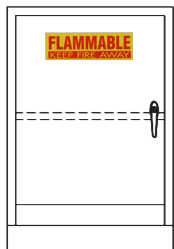

18", 24" Left Hinged

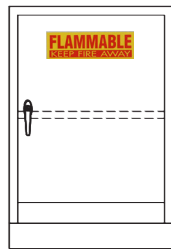

18", 24" Right Hinged

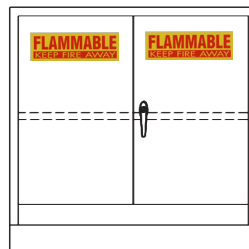

30", 36", 48"



Front view with vent outlet shown.

Flammable Cabinet Size					
Width	18"	24"	30"	36"	48"
35 1/4" high X 22" deep	18010	18020	18300	18030	18040

Venting Your Flammable Cabinet (select 1 or 2)

- ① Flammable Cabinet Vent Through Fume Hood Double Side Wall & worksurface

- (1) 90 Degree Elbow
 - (1) Vent outlet Exhaust Vent Kit
- Cat. No. 81001

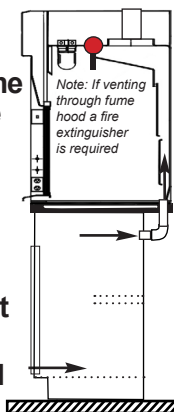

- ② Flammable Cabinet Exhaust Blower through the wall

- (1) 90 Degree Elbow Exhaust
 - (1) 10' Ridge & Flex
 - (1) Exhaust Blower Vent Outlet
- Cat. No. 81002

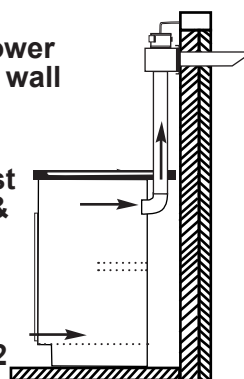

ABC Dry Chemical Fire Extinguishers



Halon Fire Extinguishers



(See page 22 for Fire Extinguisher info)

Laboratory Countertops, Sinks, and Plumbing

Countertops are available in phenolic resin (standard), epoxy resin, and stainless steel, are 24 or 30 inches deep, and can be supplied with or without back splashes. Sink and service cut-outs are fabricated as required.

Laboratory Countertops

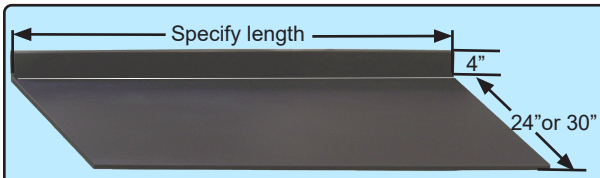

Phenolic Resin

1. Phenolic Resin Surfaces are constructed of solid composite panels that have excellent chemical resistance and durability. Surfaces are nonporous and UV, heat, bacteria, and scratch resistant. Available in 1" thickness. color: Charcoal (sold by the lineal foot) SEFA Compliant, UL1805 Certified.

Depth	24" Deep	30" Deep
No Backsplash	Cat. No. 70118	Cat. No. 70018
With 4" Backsplash	Cat. No. 70118B	Cat. No. 70018B



Epoxy Resin

2. Epoxy Resin Surfaces & curbs are molded of a modified epoxy resin that is specifically compounded & cured to provide optimum physical & chemical resistance. Surfaces are nonporous, non-conductive, stain & heat resistant. Available in 1" thickness. color: Black. (sold by the lineal foot) SEFA Compliant, UL1805 Certified.

Depth	24" Deep	30" Deep
No Backsplash	Cat. No. 70115	Cat. No. 70015
With 4" Backsplash	Cat. No. 70115B	Cat. No. 70015B

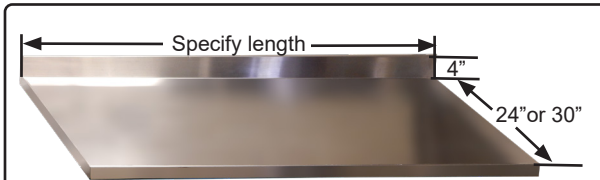

Stainless Steel

3. Stainless Steel Surfaces are fabricated of type 304, 16 gauge steel with #3 satin finish. All corners, ends, and joints are continuous Heliarc welded and ground smooth. (type 316 stainless steel available) (sold by the lineal foot)

Depth	24" Deep	30" Deep
No Backsplash	Cat. No. 70116	Cat. No. 70016
With 4" Backsplash	Cat. No. 70116B	Cat. No. 70016B

Lab Sink Deep Bowl



Epoxy, Stainless Steel or Polyolefin Sinks

Chemical resistant sinks are molded with integral flanges allowing drop-in mounting. Sinks include 1.5" IPS threaded outlet & includes sink stopper & drain outlet. Please specify location in counter top layout of A and B dimensions.

Polyolefin Sinks			
A	B	Depth	Cat. No.
12"	8"	8"	72041
14"	10"	6"	72043
18"	15"	12"	72045
28"	20"	9"	72048

Epoxy Resin Sinks			
A	B	Depth	Cat. No.
16"	12"	8"	42022
18"	15"	11"	42026
24"	16"	8"	42027
28"	15"	11"	42028

Stainless Steel Sinks			
A	B	Depth	Cat. No.
12"	12"	7.5"	42031
16"	16"	7.5"	42032
16"	22"	7.5"	42033
16"	28"	7.5"	42034

Pegboards

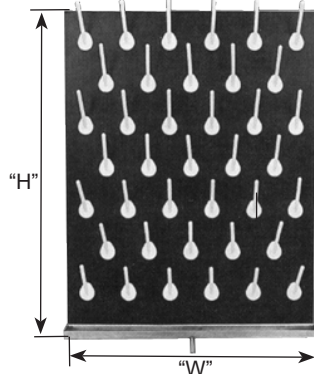

Phenolic Resin Pegboards

For drying and Storage of lab ware. Pegboard in 1" thick and includes a stainless steel drip trough to collect run-off.

W	H	No. of Pegs	Cat. No.
24"	30"	39	72430
30"	30"	46	73030
30"	36"	60	73036

Neutralization Tanks

Molded of one-piece, chemical resistant polyolefin, neutralization tanks are designed to dilute & neutralize laboratory waste & concentrated corrosives.

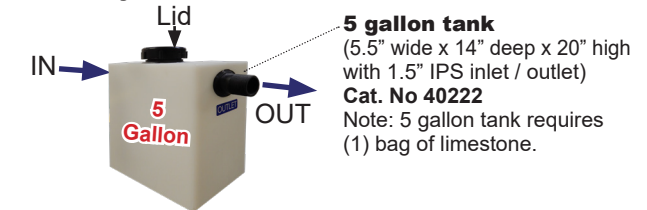

5 gallon tank
(5.5" wide x 14" deep x 20" high with 1.5" IPS inlet / outlet)
Cat. No 40222
Note: 5 gallon tank requires (1) bag of limestone.

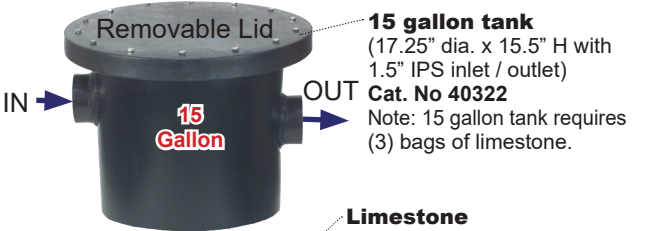

15 gallon tank
(17.25" dia. x 15.5" H with 1.5" IPS inlet / outlet)
Cat. No 40322
Note: 15 gallon tank requires (3) bags of limestone.



Limestone
is utilized as the medium for neutralizing the hazardous waste. (50 lb bag)

Note: Limestone is not included with tank. Cat. No. 40223

Cupsinks & Traps



Oval Cup Sink

Drop-in cup sink available in polyolefin. 1.5" IPS tailpiece includes strainer.

3" x 6"	Cat. No. 40119
3" x 9"	Cat. No. 40121



Round Cup Sink

Drop-in sink available in epoxy or polyolefin. 1.5" IPS tailpiece includes strainer.

Polyolefin 6"	Cat. No. 40118
Epoxy Resin 8"	Cat. No. 40218



Polyolefin Jar Trap

Trap includes adjustable tailpiece and removable jar. 1.5" tailpiece.

Cat. No. 40220

Plumbing, Electrical, and Safety Services

The countertop service fixtures are chrome-plated. All fixtures have serrated hose connections except where noted. Color-coated service handles and hole cutouts in countertop are provided. Countertop fixtures are not factory installed. Please specify services required and the fixture location.

Countertop Laboratory Plumbing



Single Gooseneck
6" swivel gooseneck for use with foot pedal remote. 3/8" NPT. ADA compliant
Cat. No. 50110-SF



Delonized Water Gooseneck Faucet
PVC faucet for distilled water. 6" rigid gooseneck. 3/8" NPT.
Cat. No. 50043



Single Service Gooseneck Faucet
Single water, 6" swivel gooseneck. 3/8" NPT.
Cat. No. 50015 with vacuum breaker
Cat. No. 50010



Deck Mounted Mixing Faucet
Hot and cold water faucet. 6" gooseneck. 3/8" NPT.
Cat. No. 50026 with vacuum breaker
Cat. No. 50018



ADA H/C Mix Gooseneck Faucet
6" swivel gooseneck with wrist handle controls. 3/8" NPT. ADA compliant.
Cat. No. 50040

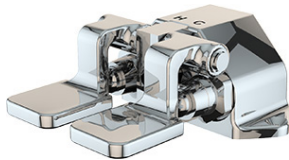

Foot Pedal Remote Control
Valves with heavy chrome plating. ADA compliant. 1/2" NPT.
Single Pedal | 50021
Double Pedal | 50020



Inline Vacuum Breaker
3/8" NPS. Dual check.
Cat. No. 51139



Aerator
Aerator for gooseneck outlet. Furnished with gasket. 3/8" NPS.
Cat. No. 50139



Aspirator Pump
Aspirator pump with 3/8" NPS male inlet.
Cat. No. 50058



Keycock
Fixture includes turret and shank connection.
Single Outlet | 50014
Double Outlet | 50014-2
Triple Outlet | 50014-3
Quad Outlet | 50014-4

Countertop Pedestal Electrical Services (UL listed)



Single Gang Outlet
Brushed cast aluminum box with stainless steel cover, surface mount. Please specify desired location of pedestal box.



Double Gang Outlet
Brushed cast aluminum box with stainless steel cover, surface mount. Please specify desired location of pedestal box.

Single Gang	Single Face	Double Face
Duplex/115 V/15a	50131S	50131D
Single/230 V/20a	50132S	50132D
GFI Duplex/115 V/20a	50135S	50135D

Double Gang	Single Face	Double Face
Duplex/115 V/15a	50031S	50031D
Single/230 V/20a	50032S	50032D
GFI Duplex/115 V/20a	50033S	50033D
One Duplex and One Single/250 V/20a	50034S	50034D



Horizontal mount

Electrical & Data Supply Chase Anodized aluminum raceway can be supplied with a variety of electrical or data services. Can be mounted in vertical or horizontal position.

- Specify length, type of plug, quantity of plugs, type of data outlet. **Cat No. 50086**

Laboratory Safety Eye / Face / Body Wash, Safety Showers



Swing-Out Eye Wash
Deck mounted next to sink. Activates when pivoted. 1/2" NPT. Barrier free.
Cat. No. 16009



Pull-Down Eye Wash
Recessed, wall mounted (4" deep), pull-down eye wash safety station. Stainless steel. 1/2" NPT. Barrier free. **Cat. No. 93968**



Hand Held Face Body Wash
squeeze valve nozzle on 8' coiled hose and bracket. Can be used to rinse body parts while victim is sitting or lying down. Wall or hood mounted, 3/8 NPT, Barrier free.
Cat No. 16005



Laboratory Safety Shower
Cat.No. 16604
see page 27

UniFlow[®] SL AireStream Fume Hoods

High efficiency, full duty fume hood in 48", 60", 72" and 96" widths. UniFlow SL AireStream fume hoods are designed for energy savings & maximum user protection. The aerodynamic face opening with airfoil provides uniform air flow through the fume chamber. A constant volume low flow hood with Vector AireStream baffle system directs the air through the fume chamber to the bell shaped exhaust outlet with minimal turbulence. Color: Lab White

UniFlow Superstructure non-metallic construction for total chemical and corrosion resistance, superior durability and long life. Interior fume chamber one piece glass smooth, all covered corners for ease of cleaning. Unitized construction reduces weight for ease of installation. 5 year warranty.

Overall Height is 54" inches with a 48" inch high interior fume chamber.

VaraFlow Baffle System Features vector flow slots for low flow and high performance. Maintains uniform air flow thru the baffle system to bell shaped exhaust collar outlet.

Access Panel removable to access ducting connections, plumbing & electrical services from a single point electrical box, 115V/60Hz AC operation. Energy efficient vapor proof LED light fixture with polished stainless steel reflectors, and light switch on left column, all factory installed.

31" Standard Vertical Sash Height

vertical moving sash for loading & unloading of fume hood. Sash is counterbalanced and connected with coated stainless steel cables, 3/16" tempered safety glass with chemical resistant non-metallic PVC framing track and aerodynamic sash lift.

Sash Stop located at 1/2 open position to reduce air flow 50%, **Cat. No. 51651**



Full 35" Viewing Height for ease of access, unobstructed view of fume chamber, and working with tall apparatus and distillation grids. Ergonomic sash lift contoured for efficient air flow and ease of movement, standard equipment.

Angled Picture Frame Sash Opening

the aerodynamic face opening with air foil provides uniform air flow into the fume chamber and thru the Vector AireStream baffle system.

Worksurface and Base Cabinet

are included as part of the fume hood package. The worksurface is a dished epoxy resin and the cabinet is a standard two door unit 35" high with powder coat finish.

Air Flow Monitor continuously monitors face velocity air flow, comes standard with analog, digital available. Meets ANSI and OSHA requirements. Optional equipment, **Cat. No. 51403**



SL AireStream Fume Hood Cat. No. 55531 shown with optional service fixtures

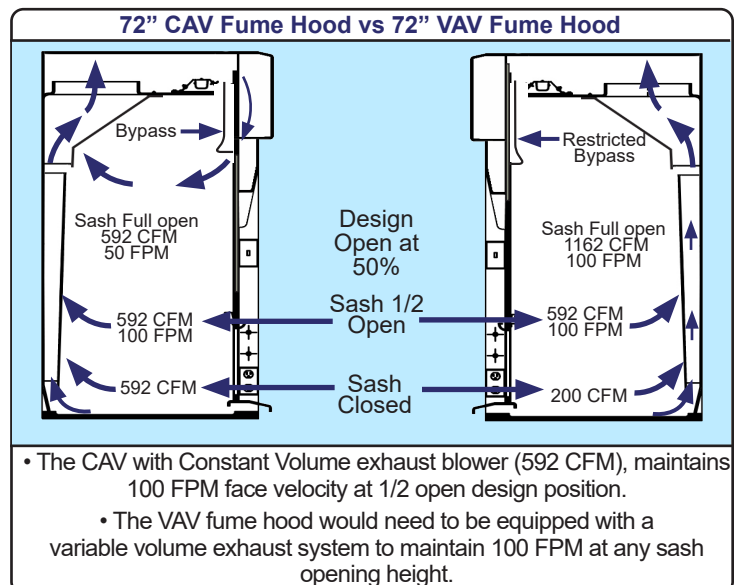

UniFlow[®] SL AireStream Fume Hoods

UNIFLOW SL AIRESTREAM FUME HOOD GROUPINGS	Fume Hood Width "A"			
	48" Cat No.	60" Cat.No.	72" CatNo.	96" Cat.No.
1. UniFlow SL CAV AireStream Fume Hood: Air Bypass low flow, constant air volume hood. Dual wall unitized construction, all non-metallic corrosion and fire resistant composite fiberglass construction. Vector AireStream Baffle System and transition bell exhaust connection. Molded one-piece fume chamber with white glass-smooth surface with all covered corners. Vertical sash to be counter balanced 3/16" tempered safety glass with chemical resistant non-metallic PVC framing, track, and aerodynamic sash lift. A sash stop is installed at the 1/2 open position. Vapor proof LED light fixture and control switch are wired to a single point junction box, 115/60Hz. AC All electrical components are U.L. listed. Fume hood is U.L.1805 classified. Fume hood comes with dished epoxy resin worksurface and standard base cabinet. Standard color: Lab White	55431	55531	55631	55831
2. UniFlow SL VAV AireStream Fume Hood: Same as #1 above except equipped with variable air volume VAV restricted by-pass feature. Ducting must be connected to optional VAV exhaust system controls.	55432	55532	55632	55832
3. UniFlow SL CAV AireStream Fume Hood with Explosion-Proof Light: Same as #1 above except, equipped with explosion proof vapor proof light fixture. Class I Division II Group A B C & D, Class II Division II Group F & G, 115V/60Hz U.L. listed fixture is installed but not wired. Must be field wired to comply with codes.	55433	55533	55633	55833
4. UniFlow SL CAV AireStream Fume Hood: Same as #1 above except equipped to comply to international electrical configuration. 220V/50Hz AC Optional international electrical configuration, electrical switches, receptacles available.	55434	55534	55634	55834
5. Horizontal Sliding Sash Option: Add suffix to number above	55HS-4	55HS-5	55HS-6	55HS-8
6. Combination Sliding Sash Option: Add suffix to number above	55CS-4	55CS-5	55CS-6	55CS-8

Questions / Ready to order
Call: 800-779-4362

Hood Width A	48"	60"	72"	96"
Interior Width C	38"	50"	62"	86"
Diameter D	12"	12"	12"	(2) 12"

CAV Fume Hood Face Velocity 

The recommended face velocity for efficiency & safety is 80-100 FPM. Lower face velocity may compromise user safety.

Sash in full open position should be for setup of apparatus & maintenance service only. Design opening is at 1/2 open at 100 FPM (feet per minute), face velocity at full open would be approximately 50 FPM.

Size Hood	36"	48"	60"	72"	96"
1/2 Open	241	385	474	592	800
1/2 Open Static Pressure	.04	.06	.10	.13	.08
Full Open	438	773	938	1162	1613

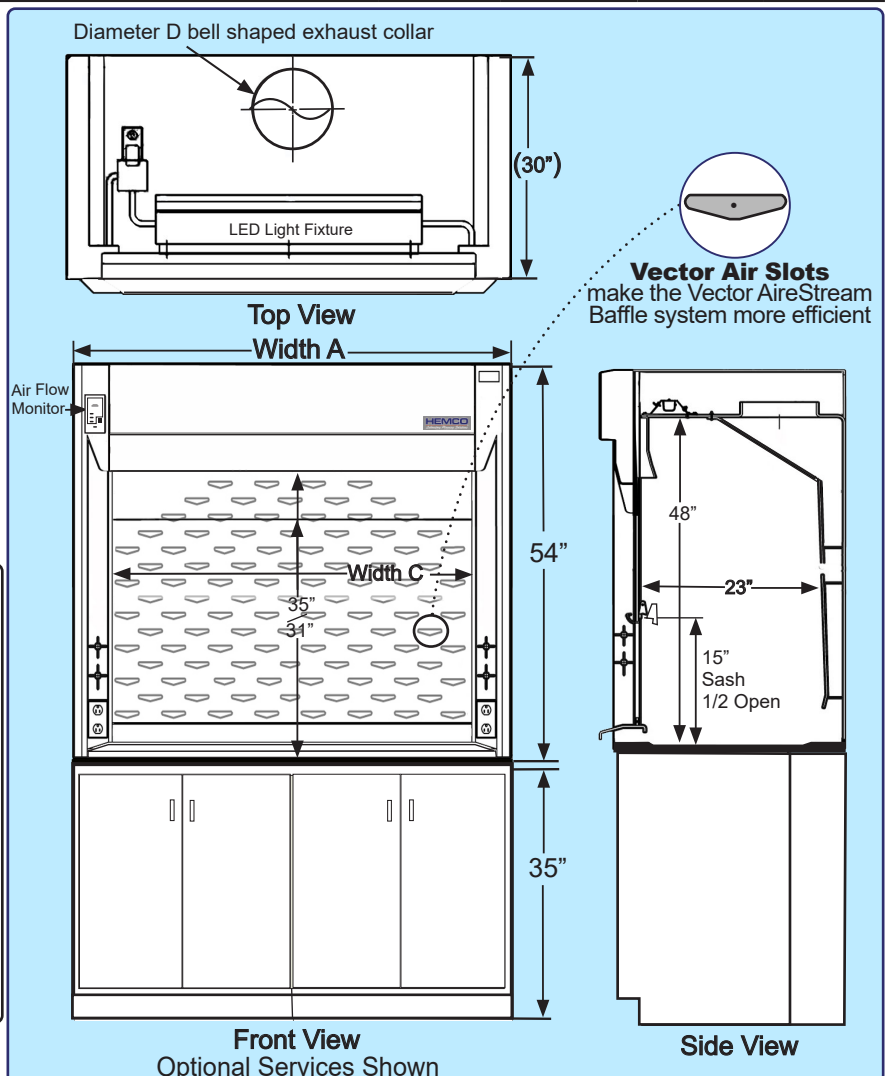

HEMCO Plan-A-Hood Worksheet

The Following is a sample of the UniFlow SL Plan-A-Hood Worksheet. Easily specify your fume hood to your exact requirements. Review worksurfaces, base cabinets, plumbing and electrical fixtures. To access go to www.HEMCOcorp.com select the model and click on the Plan-A-Hood link. Standard color: Lab White

UNIFLOW FUME HOOD	QTY	CAT. NO.
AIR BY PASS / CAV		
CONVENTIONAL / VAV		
AUXILIARY AIR		
DISTILLATION		
RADIOISOTOPE		
PERCHLORIC ACID		
ADA		

AIR FLOW MONITOR	QTY	CAT. NO.
DIGITAL		
ANALOG		
OTHER		

SASH	QTY	CAT. NO.
VERTICAL MOVING STD		
HORIZONTAL MOVING		
COMBINATION H&V		

SASH STOP	QTY	CAT. NO.
SPECIFY LOCATION		

PLUMBING SERVICES*	QTY	CAT. NO.
SERVICE SET OF FOUR		

*SPECIFY AIR,GAS,VAC,C/W OR OTHER

ELECTRICAL SERVICES	QTY	CAT. NO.
DUPLEX RECEPT. 125V, 15A		
DUPLEX RECEPT. 125V, 20A		
SIMPLEX RECEPT. 250 V		
DUPLEX GFI 125V, 15A		
DUPLEX GFI 125V, 20A		

ACCESS PANEL	QTY	CAT. NO.
INSIDE LOCATION		
OUTSIDE LOCATION		

CABINETS	QTY	CAT. NO.
SINK CABINET		
BASE CABINET		
ACID CABINET		
FLAMMABLE CABINET		

UniFlow SL AireStream

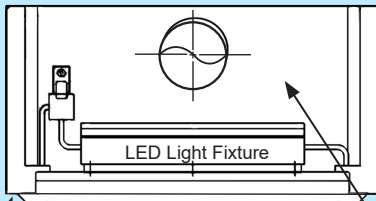

TOP VIEW

Fill out this form and email to:
info@hemcocorp.com

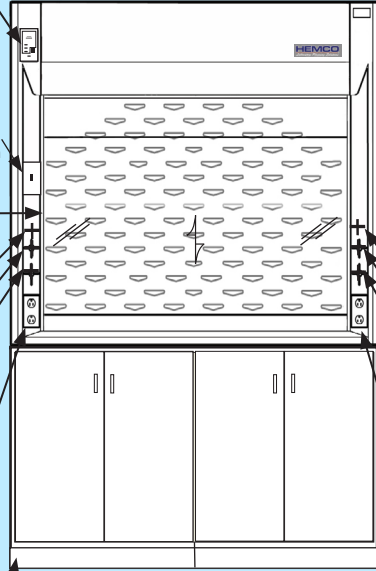

FRONT VIEW WITH BASE CABINET
Optional services shown
(see 17 for service options)
Service Slot

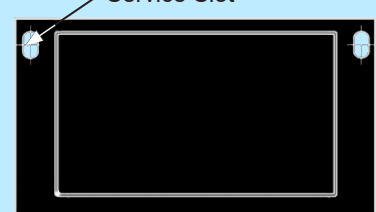

PLAN VIEW OF WORKSURFACE

Questions / Ready to order
Call 1-800-779-4362

CUSTOMER NOTES		
<input checked="" type="checkbox"/> LABORATORY FUME HOODS		
<input checked="" type="checkbox"/> GASEWORK		
<input checked="" type="checkbox"/> WORKSURFACE		
<input checked="" type="checkbox"/> LABORATORY FUME HOOD		
<input checked="" type="checkbox"/> SPECIFY HEMCO		

FIRE EXTINGUISHER	QTY	CAT. NO.
20 SQ FT DRY CHEMICAL		
30 SQ FT DRY CHEMICAL		
50 CU FT HALON		
125 CU FT HALON		

BLOWER SWITCH	QTY	CAT. NO.
TOGGLE SWITCH 125V, 15A		
TOGGLE SWITCH 125V, 20A		
TOGGLE SWITCH. 250V, 20A		
TOGGLE SWITCH W/PILOT		
MOTOR STARTER SWITCH		

PLUMBING SERVICES*	QTY	CAT. NO.
SERVICE SET OF FOUR		

*SPECIFY AIR,GAS,VAC,C/W OR OTHER

ELECTRICAL SERVICES	QTY	CAT. NO.
DUPLEX RECEPT. 125V, 15A		
DUPLEX RECEPT. 125V, 20A		
SIMPLEX RECEPT. 250 V		
DUPLEX GFI 125V, 15A		
DUPLEX GFI 125V, 20A		

ACCESS PANEL	QTY	CAT. NO.
INSIDE LOCATION		
OUTSIDE LOCATION		

WORKSURFACE	QTY	CAT. NO.
EPOXY RESIN		
PHENOLIC RESIN		
304 STAINLESS STEEL		

Tips for Fume Hood Layout:

- Cupsinks or sinks cannot be located directly above acid or flammable Storage cabinets; unless behind the cabinet.
- Locate service fixtures 6" back from the sash.
- Service fixture access panels are located on the exterior side walls. Please specify if required on the interior side walls.
- Exhaust blowers and filters can be sized to your application, consult factory.

Fume Hood Worksurfaces & Base Cabinets

A complete line of worksurfaces and cabinets to suit any application from economical light duty to heavy acid and solvent use. Select the worksurfaces and cabinets that meet your laboratory's requirements. Standard sizes are listed below. HEMCO's technical staff can make recommendations to suit your specific needs.

(UniFlow SL hoods 30" only) Epoxy Resin, color: black, 1-1/4" thick, 3/8" dished



Cast Epoxy Resin Worksurfaces are recommended for general laboratory work where greater chemical resistance is required. Surface is dished 3/8" to contain spillage. Worksurface is cast of thermosetting epoxy resin, creating a molded solid 1-1/4" thick top which is extremely hard, abrasion and heat resistant. Tested to UL 1805 classification.

SL Size	Cat. No.	Size	Cat. No.
36"W x 30"D	20315	36"W x 36"D	20325
48"W x 30"D	20415	48"W x 36"D	20425
60"W x 30"D	20515	60"W x 36"D	20525
72"W x 30"D	20615	72"W x 36"D	20625
96"W x 30"D	20815	96"W x 36"D	20825

(UniFlow SL 30" only) Phenolic Resin, color: black, 1-1/4" thick

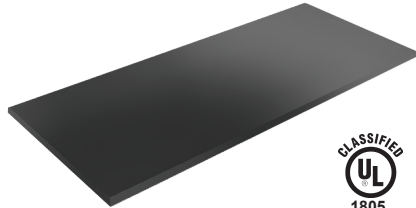

Phenolic Resin Worksurface are recommended for general laboratory work where high concentrations of solvent, acids and alkalis are being worked with. Work surface combines excellent chemical resistance scratch and wear resistance. Surface is flat 1-1/4" thick. Tested to UL 1805 classification.

SL Size	Cat. No.	Size	Cat. No.
36"W x 30"D	21428	36"W x 36"D	22428
48"W x 30"D	21418	48"W x 36"D	22418
60"W x 30"D	21518	60"W x 36"D	22518
72"W x 30"D	21618	72"W x 36"D	22618
96"W x 30"D	21818	96"W x 36"D	22818

(UniFlow SL 30" only) Stainless Steel, satin finish, 1-1/4" edge, 3/8" dished

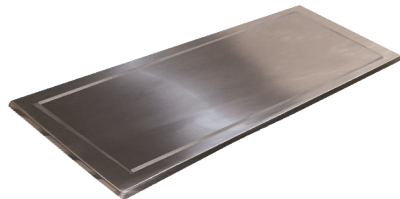

Stainless Steel Fume Hood Worksurfaces are fabricated of type 304, 16 gauge steel with #3 satin finish. Surface is dished 3/8" to contain spillage. All corners, ends, and joints are continuous 1-1/4" heliarc welded and ground smooth. Type 316 stainless steel is also available.

SL Size	Cat. No.	Size	Cat. No.
36"W x 30"D	20316	36"W x 36"D	20326
48"W x 30"D	20416	48"W x 36"D	20426
60"W x 30"D	20516	60"W x 36"D	20526
72"W x 30"D	20616	72"W x 36"D	20626
96"W x 30"D	20816	96"W x 36"D	20826

Fume Hood Base Cabinets & Tables

Standard cabinets and tables are 35" high and 22" deep. For 36" wide use (1) 36", for 48" wide (1) 48", for 60" wide (2) 30", for 72" wide (2) 36", For 96" wide (2) 48". Standard color: Lab White, (optional colors are available as required)

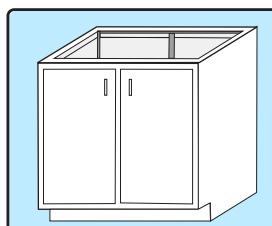

Base Cabinet
Constructed of furniture grade steel. With adjustable shelf and levelers. Standard depth is 22", standard height is 36".

Width	Doors	Cat. No.
24"	1	52411
30"	2	53011
36"	2	53611
48"	2	54811
60"	2	56011

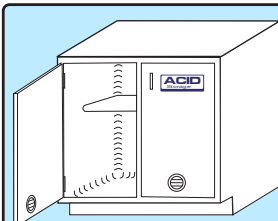

Acid Cabinet Interior is lined with one piece acid resistant white composite resin liner and all covered corners, for superior corrosion resistance, with containment tray, vents and fixed shelf. Standard depth is 22", standard height is 36".

Width	Doors	Cat. No.
12"	1	15120
18"	1	15180
24"	1	15240
30"	2	15300
36"	2	15360
42"	2	15420
48"	2	15480
Vent Kit	---	81000

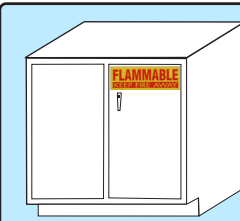

Flammable Cabinet provides safe Storage of flammables. Color: Lab White. Constructed of welded double wall furniture grade steel. Cabinet has an adjustable shelf and locking hinged doors. Meets NFPA codes. Standard depth is 22", standard height is 36".

Width	Doors	Cat. No.
24"	1	18020
30"	2	18300
36"	2	18030
48"	2	18040
Vent Kit	--	81000

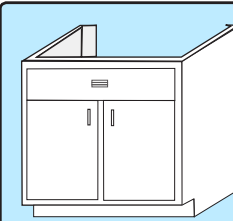

Sink Unit Cabinet
Constructed of furniture grade steel. Cabinet has hinged doors and levelers. Standard depth is 22", standard height is 36".

Width	Doors	Cat. No.
24"	1	71810
30"	2	71811
36"	2	71812
48"	2	71814
60"	2	71815

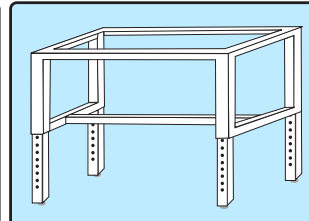

Fume Hood Base Table
Heavy duty, all welded 2" square tube steel construction. Standard depth is 22". Each leg has levelers with fitted black boots. Available in, standard 36" bench height, & 28" sitting height. ADA height 34"

Width	Depth	Std
36"	22"	53612
48"	22"	54812
60"	22"	56012
72"	22"	57212
96"	22"	59612

Fume Hood Wall Mounted Plumbing Fixtures

Fume hood remote control service fixtures feature epoxy coated brass, chemical resistant, color-coded, serrated hose connections, and 3/8" NPT brass valves with rod and handle assembly. Plumbing fixtures are factory installed on hood, they can be pre-plumbed if specified. Please specify service required, fixture location, and inside or outside service access panels. Conforms to ANSI Z21.15.

Service Fixture Color Code Chart	Green - Cold Water	Red - Hot Water	Blue - Gas	Orange - Air
	Yellow - Vacuum	Brown - Nitrogen	Black - Steam	White - Deionized Water



Service Set of Two (specify left or right mounting)
Two remote controlled service fixture set. Color-coded index buttons with matching color-coded serrated tip. Specify service required. Epoxy coated brass.
Cat. No. 50121-FS



Service Set of Four (specify left or right mounting)
Four remote controlled service fixture set. Color-coded index buttons with matching color-coded serrated tip. Specify service required. Epoxy coated brass.
Cat. No. 50141-FS



Service Set of Six (specify left or right mounting)
Six remote controlled service fixture set. Color-coded index buttons with matching color-coded serrated tip. Specify service required. Epoxy coated brass.
Cat. No. 50161-FS



DI Faucet
Pure water 6" rigid PVC gooseneck.
Cat. No. 50019



DI Faucet
Pure water 6" swivel tin-lined gooseneck. Epoxy coated brass.
Cat. No. 50022



Gooseneck PVC Service Fixture
Wall mount, no valve, constructed of PVC.
Cat. No. 51110



Service Fixture
Cold water, remote controlled epoxy coated brass turret.
Cat. No. 50012



Water Faucet with Vacuum Breaker
Cold water 6" swivel gooseneck. Epoxy coated brass.
Cat. No. 50023



Water Faucet with Vacuum Breaker
Cold water remote controlled 6" swivel gooseneck. Turret & gooseneck are epoxy coated brass. **Cat. No. 50113-CW**



Water Faucet
Cold water remote controlled 6" swivel gooseneck. Turret and gooseneck are epoxy coated brass.
Cat. No. 50112-CW



Service Fixture
Remote controlled single service outlet. color-coded index buttons with matching color coded serrated tip outlets.
Cat. No. 50013



Base Fixture
Deck or wall mount, 3/8 NPT remote, no valve. PVC.
Cat. No. 51013



PVC Lab Turret
Deck or wall mount, 3/8 NPT, no valve, PVC.
Cat. No. 51012



Mix Faucet
Hot and cold remote controlled 6" swivel gooseneck. Turret and gooseneck are epoxy coated brass.
Cat. No. 50102



Mix Faucet
Hot and cold water remote controlled turret. Turret is of epoxy coated brass.
Cat. No. 50101



High Flow Water Valve, Straight Pattern
Ball valve construction with quarter turn open / close, used for supply and return connections.
Cat No. 51023



Single Keycock
Single flange mounted needle valve, keycock with integral flange and shank connection. Epoxy coated brass. 3/8" NPT with lock nut.
Single Cat. No. 50025
Double Cat. No. 50125



Aspirator
3/8" NPS male inlet
Epoxy coated brass.
Cat. No. 50058



External Mounted Vacuum Breaker
Breaker with 3/8" IPS inlet and outlet. Chrome plated brass. **Cat. No. 50044**

Fume Hood Electrical Services

Electrical services are UL, CSA & CE listed. They come factory installed, wired to a single point junction box when ordered with fume hoods. Services must be wired to comply with local codes.

Fume Hood Electrical Services (UL)



Duplex Receptacle
115V single phase receptacle. Installed on front column of fume hood. Includes junction box and cover plate. UL listed.

amps	Cat. No.
15 amps	50029-1
20 amps	50029-2



Single Receptacle
230V single phase receptacle. Installed on front column of fume hood. Includes junction box and cover plate. UL listed.

amps	Cat. No.
15 amps	50030-1
20 amps	50030-2



GFI Duplex
115V consists of combination ground fault interrupters, 3-wire polarized grounded. Includes junction box & cover plate. UL listed.

amps	Cat. No.
15 amps	50048-1
20 amps	50048-2



Data Port
Cat 6, 10 gigabit ethernet, (2) port fixture. Installed on front column. Cabling not included.

Cat No. 50053



Light Switch (standard)
115V/15 amps. Includes junction box and cover plate. UL listed.

Cat. No. 50028-1



Blower Switch with Pilot Light
Includes junction box and cover plate. UL listed.

volts/amps	Cat. No.
115V 15 amps	50027-1
230V 20 amps	50027-3



Blower Switch
Mounted in a single gang receptacle box with face plate. Factory mounted not wired. Includes thermal overload protection. Double pole switch for up to 1 HP, single phase, 60 Hz 115V 50 Hz, 230V AC motors. UL listed.

Cat. No. 50050



Service Port Pass-Through
Convenient port allows cords, tubes, or cables to pass to and from the hood.

Cat. No. 50100

Fume Hood Vapor Proof Light Fixtures (UL)



Vapor-Proof Light

Factory installed. Accepts bulb up to 150w, 115V, & LED UL listed, (bulb not included) Standard on CE, Canopy, Universal and EcoFlow hoods.

Cat. No. 50035

Vapor Proof LED Light Fixture



LED fixture with Stainless steel reflector, (2) tube, 115V, UL listed. (LEDs included) LED has a 50,000 hour average life span. Standard on SE and LE Fume hoods.

24 inch.....	Cat. No. 51124
36 inch.....	Cat. No. 51136
48 inch.....	Cat. No. 51148

Fluorescent Lighting



T-5 fixture with Stainless steel reflector, (2) tube, 115V/230V tubes changed from the outside. (fluorescent tubes are included) UL listed. Optional on SE and LE Fume hoods.

24 inch.....	Cat. No. 50224
36 inch.....	Cat. No. 50236
48 inch.....	Cat. No. 50248

Fume Hood Explosion Proof Light Fixtures and Services (UL)



Explosion-Proof Light Std Class I Div II

For use in hazardous locations. Gray, two-coat epoxy finish with easily removed prismatic globe. Factory mounted, not wired. Accepts compact fluorescent or LED, (bulb not included) 115V /230V UL listed. Class I Div II Group A, B,C,D Class II Div II Group F & G

Cat. No. 50034



Explosion-Proof Fixture Class I Div I

For use in hazardous locations. Gray, two coat epoxy finish with easily removed prismatic globe. Accepts compact fluorescent or LED, (bulb not included) 115V/230V. Factory mounted, not wired. UL listed. Class I Div I Group C, D, Class II Div II Group E, F & G

Cat. No. 50038

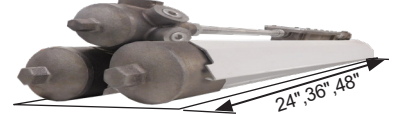

Explosion-Proof Fluorescent Lighting Class I Div I

fixture is (2) tube, 115V/230V with tubes changed from the outside. UL listed. (fluorescent tubes are included)

24 inch..... Cat. No. 50077
48 inch..... Cat. No. 50078



Explosion-Proof Switch Class I Div I or II

For use in hazardous locations. Surface mount type with cast aluminum housing. Specify 115V/20 amp or 230V/20 amp. UL listed.

Cat. No. 50036



Explosion-Proof Plug Class I Div I or II

Adaptable for use with all receptacles. 3-pole, 2-wire, Specify 115V/20 amp or 230V/20 amp AC. Not installed at factory. UL listed.

Cat. No. 50039



Explosion-Proof Receptacle Class I Div I or II

For use in hazardous locations. Surface mount type with aluminum housing, 3-pole, 2-wire, Specify 115V/20 amp or 230V/20 amp. Not installed at factory. UL listed.

Cat. No. 50037



Explosion-Proof Ground Fault Interrupter

For use in hazardous locations. Factory sealed GFI is designed to interrupt a circuit when a ground fault is detected. 115V 60 Hz, 20 amp. Not installed at factory. UL listed.

Cat. No. 50104

Fume Hood International Electrical Services (CE)

Continental European Socket with cover cap



Type: CEE7
color: gray
Rating 250V/16 amp, installed at factory.

Cat. No. 50004

Indian / South Africa Socket ISA



Type: BS546
color: white
Rating 250V/15 amp, installed at factory.

Cat. No. 50006

United Kingdom / Ireland Shuttered Socket



Type: BS1363
color: white
Rating 250V/13 amp installed at factory.

Cat. No. 50007

Continental European Panel Mount Socket



Type: CEE7
color: white
Rating 250V/15 amp installed at factory.

Cat. No. 50008

Fume Hood Sink and Plumbing Services

A complete line of sinks in epoxy resin, polypropylene, and stainless steel. We also offer a wide variety of plumbing accessories including neutralization tanks and bead baths. HEMCO welcomes the opportunity to quote your special applications. Additional sink sizes are available. Contact factory for more details. Conforms to ANSI Z21.15.

Epoxy Resin Fume Hood Laboratory Sinks



Epoxy Resin Sink Laboratory sink made of chemical and corrosion resistant epoxy resin. Drop-in sink. color: black. Please specify desired location. Includes sink stopper & drain outlet.

	Size	Cat. No.
1	9" x 6" x 6" deep	42021
2	16" x 12" x 8" deep	42022
3	18" x 15" x 11" deep	42026
4	24" x 16" x 8" deep	42027

Polypropylene Fume Hood Laboratory Sinks



Polypropylene Sink Laboratory sink made of chemical resistant heavy duty polypropylene. Drop-in sink. color: black. Please specify desired location. Includes drain outlet.

	Size	Cat. No.
1	12" x 8" x 8" deep	72041
2	14" x 10" x 6" deep	72043
3	18" x 15" x 12" deep	72045
4	28" x 20" x 9" deep	72048

Stainless steel Fume Hood Laboratory Sinks



Stainless Steel Sink Laboratory sink made of one-piece, type 304 stainless steel and polished to a No. 4 satin finish. Drop-in sink. Underside is sound deadened to reduce drumming. Specify location. Includes drain outlet.

	Size	Cat. No.
1	12" x 12" x 7.5" deep	42031
2	16" x 16" x 7.5" deep	42032
3	16" x 22" x 7.5" deep	42033
4	16" x 28" x 7.5" deep	42034

Fume Hood Cup Sinks & Plumbing Fixtures



Cupsink 6" Diameter

Cupsink is made of polyolefin with 1.5" IPS tailpiece and outlet strainer.
Cat. No. 40118



Oval Cup Sink

Drop-in cup sink available in polyolefin. 1.5" IPS tailpiece includes strainer.

3" x 6"	40119
3" x 9"	40121



Oval Wall Cupsink 6" x 3"

Cupsink is made of polyolefin with 1.5" IPS tailpiece and outlet strainer.
Cat. No. 40419



Jar P Trap

P-trap includes adjustable tailpiece and removable jar. with 1.5" IPS tail piece.
Cat. No. 40220



P Trap

P-trap is made of polypropylene with 1.5" IPS tailpiece.
Cat. No. 40120

Neutralization Tanks



15 gallon tank

(17.25" dia. x 15.5" H with 1.5" IPS inlet / outlet)

Cat. No 40322

Note: 15 gallon tank requires (3) bags of limestone.



Molded of one-piece, chemical resistant polyolefin Neutralization tanks are designed to dilute and neutralize laboratory waste and concentrated corrosives.

5 gallon tank

(5.5" wide x 14" deep x 20" high with 1.5" IPS inlet / outlet)

Cat. No 40222

Note: 5 gallon tank requires (1) bag of limestone.



Limestone

is utilized as the medium for neutralizing the hazardous waste. (50 lb bag)

Note: Limestone is not included with tank.

Cat. No. 40223

Apparatus Grids and Fire Extinguishers

Distillation apparatus grids are designed to mount small apparatus and glassware in the interior of the fume hood, maximizing the work area. Grids are available in aluminum, stainless steel, or fiberglass to meet specific needs. Mounting options: 1. Grids can be mounted to the side walls of the fume hood, 2. When more strength is required, grids can mount to both the sidewalls and the worksurface, consult factory for details.

Fume Hood Apparatus Grids

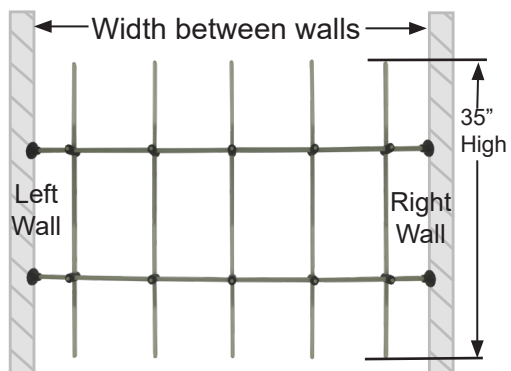

Fume hood with apparatus grid installed

Aluminum Apparatus Grid				
Fume Hood Width	48"	60"	72"	96"
Grid Width for Hood as Installed	36"	50"	62.5"	86.5"
Aluminum Rod Assembly 1/2" dia.	50141	50151	50161	50181

- All components are machined from solid aluminum bar stock.
- All aluminum lattice rod components are furnished with a satin (brushed) finish.
- Backing plates for hood wall and mounting screws for flanges are not included.

Stainless Steel Apparatus Grid				
Fume Hood Width	48"	60"	72"	96"
Grid Width for Hood as Installed	35"	46"	56"	81"
Stainless Steel Assembly 1/2" dia	50142	50152	50162	50182

- Stainless steel components offer superior strength and corrosion resistance for even the most demanding applications.
- All components are machined from Type 316 stainless steel bar stock and polished to a satin finish.
- Backing plates for hood wall and mounting screws for flanges are not included.

Non-Metallic Composite Apparatus Grid				
Fume Hood Width	48"	60"	72"	96"
Grid Width for Hood as Installed	35"	46"	56"	81"
Fiberglass Rod Assembly 1/2" dia.	50143	50153	50163	50183

- All rod components are white fiberglass.
- All connectors are molded in black nylon for strength and chemical resistance.
- Backing plates for hood wall and mounting screws for flanges are not included.
- Half open style clamps, facilitate adding or removing rods from existing assembly.

Fire Extinguishers for Flammable Hazards in flammable cabinets vented through fume hood

Foremost: Fume hood fires must be extinguished promptly, failure to do so could result in loss of life and valuable equipment & processes. In case of a fire inside of a fume hood. 1. Lower the sash into the closed position. 2. Pull the manual front mount discharge cable to activate the fire extinguisher. 3. Shut off the fume hood blower on the fume hood, and any remote exhaust blowers that are connected. 4. Shut off any utility services that could feed a fire. Fire extinguisher activation occurs at 165° Fahrenheit. These are recommendations, contact your laboratory safety officer for guidelines.

ABC Dry Chemical Fire Extinguishers



1. Fire Extinguisher with automatic activation at 165° Fahrenheit.
 - With dry chemical for class ABC fires, 16 Square feet.....Cat No. 53030

Halon Fire Extinguishers



2. Fire Extinguisher with automatic activation at 165° Fahrenheit.
 - With Halon, up to 50 Cubic feet.....Cat No. 53050
 - With Halon, 125 Cubic feet.....Cat No. 53125
- Manual Discharge Cable Kit.....Cat No. 53007

Manual discharge cable kit **Note:** Larger hoods may require (2) or more extinguishers, based on interior cubic dimensions.

HEMCO Fume Hood Materials & Chemical Resistance Chart

UniFlow Fume Hoods are constructed of white composite Fiberglass Reinforced Polyester (FRP) material. FRP is an excellent general purpose material for fume hood construction.



- Superstructure features unitized dual wall construction with integral one-piece fume chamber for total chemical resistance, non-sparking construction, for hazardous locations.
- UniFlow HiPel FRP Composite construction is UL 1805 Classified for Laboratory Fume hoods and cabinets.
- HEMCO HiPel FRP Composite conform to NFPA 45 for products used in laboratories.
- To provide for the best airflow performance through the fume chamber, any heat generating equipment should be elevated 2" to 3" above work surface and 4" to 6" away from side walls and rear baffle system, and at least 6" away from the sash opening.

Chemical resistance of HEMCO's most widely used FRP composite construction, and other liner material options.

N = No Effect S = Slight Effect B = Bad Effect NA = Data Not Available

Chemical	HEMCO HiPel FRP Composite	Polyvinyl Chloride (PVC)	High Density Polyethylene (HDPE)	Polypropylene (PP)	304 Stainless Steel (SS)	316 Stainless Steel (SS)	Worksurfaces	
							Epoxy Resin	Phenolic Resin
Acetic Acid	N	N	NA	N	S	N	N	NA
Acetone	N	B	N	N	N	N	N	NA
Ammonium Hydroxide	N	N	NA	N	N	N	N (28%)	NA
Benzene	N	B	S	B	N	N	N	B
Carbon Tetrachloride	N	B	B	B	N	N	N	N
Chromic Acid	N	S	NA	B	N	N	S (40%)	B
Diethyl Ether	N	B	NA	B	N	N	N	NA
Ethyl Alcohol	N	N	N	N	N	N	N	NA
Gasoline	N	N	B	NA	N	N	N	N
Hydrogen Peroxide	N	N	N	N	NA	NA	N	B
Hydrochloric Acid	N	N	N	N	B	B	S	NA
Kerosene	N	N	NA	B	N	N	N	N
Methyl Alcohol	N	S	N	N	N	N	N	NA
Methyl Ethyl Ketone	N	B	B	NA	N	N	NA	N
Nitric Acid	N (20%)	N	N	B	B	B	N	NA
Sodium Chloride	N	N	N	NA	S (10%)	N (10%)	S (10%)	N
Sodium Hydroxide	N	N	N	N	N	N	S (10%)	B
Sodium Hypochlorite	N	N	B	N	N	N	N	NA
Sodium Sulfide	S	N	N	NA	N	N	NA	B
Sulfuric Acid	N (33%)	N (70%)	N (80%)	N	S (80%)	N (80%)	N (60%)	B (75%)
Sulfuric Acid (conc.)	S	S	S	N	B	S	B	B
Flame Spread	< 25	NA	NA	NA	0	0	NA	NA
Fuel Contributed	0	NA	NA	NA	0	0	NA	NA
Smoke Developed	500	NA	NA	NA	0	0	NA	NA

Tables & Worksurfaces

Standard Tables for Unitized Enclosures

- Available in 4', 5', 6' & 8' widths. Depths of 30" & 36".
- Tested to 2000 lb. load capacity.
- Adjustable telescoping 2" square steel legs adjust to 28", 30", 32" & 34" heights.
- Sturdy dual locking bolts on each leg.
- Height adjustable leveling legs on all four legs.
- Standard color: Lab White, (optional colors are available as required)
- SEFA Certified
- Black Phenolic Worksurface (not included)



Standard Lab Tables

Shown with optional locking casters for mobility, and worksurface

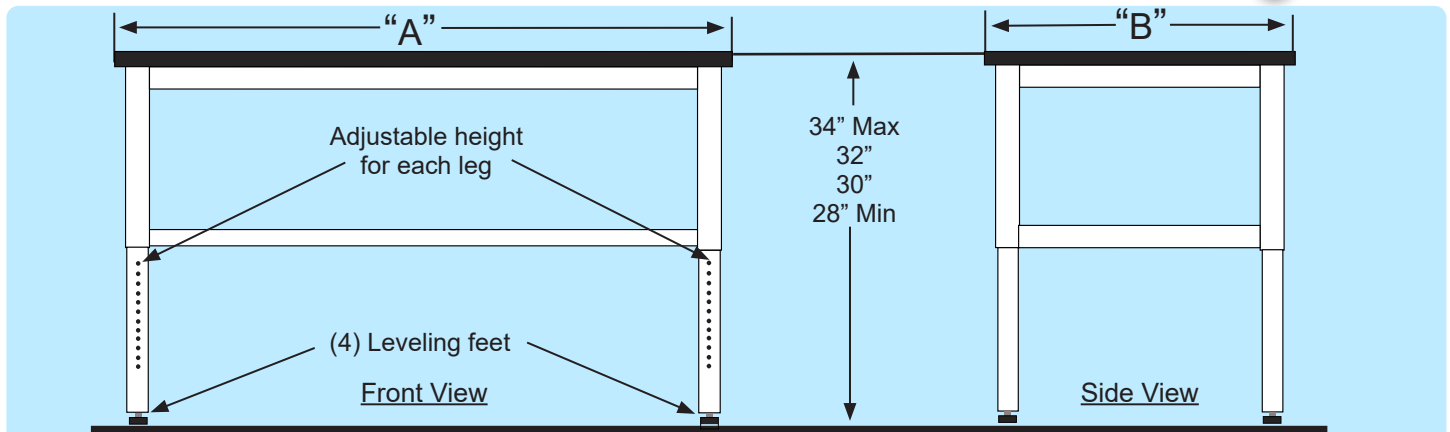

Depth "B"	Heavy Duty Tables			
	Width "A"			
	48"	60"	72"	96"
30"	54831	56031	57231	59631
36"	54832	56032	57232	59632
Epoxy Worksurfaces				
30"	20425	20525	20625	20825
36"	20435	20535	20635	20835
Phenolic Worksurfaces				
30"	20428	20528	20628	20828
36"	20438	20538	20638	20838
Casters (4) Heavy Duty, with 2 locking Cat.No. 54444				

T - Frame Mobile Tables

The table is adjustable from 30 to 36 inches in height. It is of welded steel construction with a phenolic resin work surface.

Mobile table is an ideal lab cart and can accommodate:

- MicroFlow I, II & III Workstations
- Demonstration Hoods
- VSE Vented Safety Enclosures
- Table Top Fume Hoods
- Welded all steel construction, chemical resistant epoxy powder coated finish color white.
- (2) locking casters & (2) Non-locking Casters included
- Phenolic resin worksurface

Mobile Table 36" wide	50318
Mobile Table 48" wide	50418

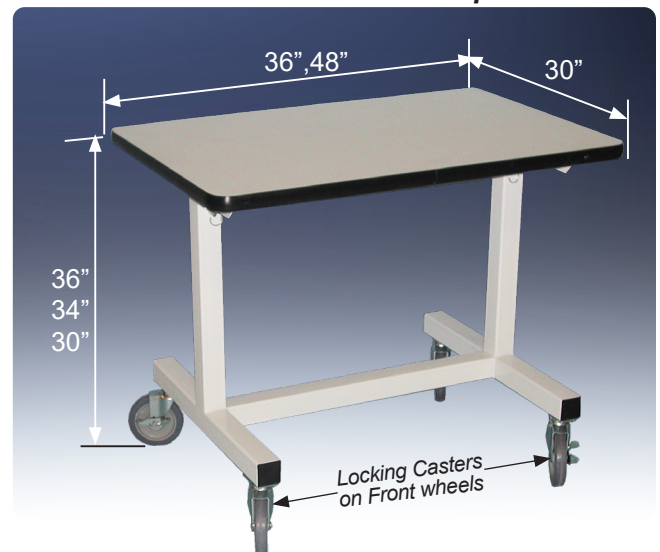

Energy Savings Ventilation Recommendations

A comparison of two fume hoods below is based on a designed 12" high operating sash height with sash management and a full open sash height without sash management. By maintaining a lower operating height, energy can be conserved, material costs saved, and user safety enhanced. Sash Management can SAVE 57% on fume hood operating cost.

Energy Savings

Annual cost to operate \$8190.00

1. UniFlow 72" CAV bypass fume hood **WITHOUT** sash management requires 1170 CFM to maintain 100 FPM (face velocity) with the sash fully open. At an average of \$7.00 per CFM, the annual cost to operate this fume hood would be \$8190.00

2. UniFlow 72" CAV bypass fume hood **WITH** sash management only requires 500 CFM to maintain 100 FPM (face velocity) with operating height at 14". At an average of \$7.00 per CFM, the annual cost to operate this fume hood would be \$3500.00

Annual cost to operate \$3500.00

Total Energy SAVINGS = \$4690.00 per year

Equipment Savings

Based on 20' of ducting, (1) 90° elbow, stack outlet, and exhaust blower

UniFlow 72" CAV bypass fume hood **WITHOUT** sash management would require 12" diameter ducting to handle the volume and duct velocity at \$200.00 per foot.

UniFlow 72" CAV bypass fume hood **WITHOUT** sash management an exhaust blower designed to maintain 100 FPM (face velocity) would require 1170 CFM @ 0.75" w.g. (static pressure) with a 10" diameter inlet and 1/2 hp motor at \$3720.00

UniFlow 72" CAV bypass fume hood **WITH** sash management would only require 8" diameter ducting to handle the volume and duct velocity at \$143.00 per foot.

UniFlow 72" CAV bypass fume hood **WITH** sash management an exhaust blower designed to maintain 100 FPM (face velocity) with sash at 14" operating height, would only require 500 CFM @ 0.75" w.g. (static pressure) with a 9" diameter inlet and 1/4 hp motor at \$3264.00

Total Equipment SAVINGS ducting & blower = \$1617.00

Importance of Duct Velocity

Duct Velocity is important to the safe ventilation of laboratory fumes & particulate, 1200 to 1500 FPM (duct velocity) is recommended. A 72" fume hood with 1170 CFM (for full sash opening) will have a 12" diameter belled outlet duct connection & will maintain 1400 FPM duct velocity. A 72" fume hood with 500 CFM (for 12" sash opening) will have an 8" diameter belled outlet duct connection & will maintain 1400 FPM duct velocity for over a 50% reduction in volume.

Importance of Room Air Changes per Hour

10-12 Air Changes per Hour is typical to a laboratory and in some cases the fume hood not only exhausts hazardous fumes but serves as the general ventilation of the lab. The lab should always be under negative pressure; thus 10% of the exhaust should come in from the corridor under or around the door. For example, a 12' x 25' x 9' high room, at 2700 cu ft, would require approximately 450 CFM. With the hood at 500 CFM and 10% of that coming from the corridor, the minimum supply in the room would be 450 CFM. However if a greater amount is brought in, there would need to be general exhaust from the room to prevent the room from being pressurized.

Make-Up Air, Considering that a fume hood exhausts a large amount of air from the lab space, it is necessary to ensure that there is sufficient air supply to the lab, yet still maintaining a negative air pressure to the surrounding area.

Because of the additional resistance in the duct system, the static pressure of in-line filtration would need to be calculated when sizing the exhaust fan.

Filtration, Depending on the contaminant, an inline HEPA or carbon filter may be necessary to prevent pollution to the outside environment.

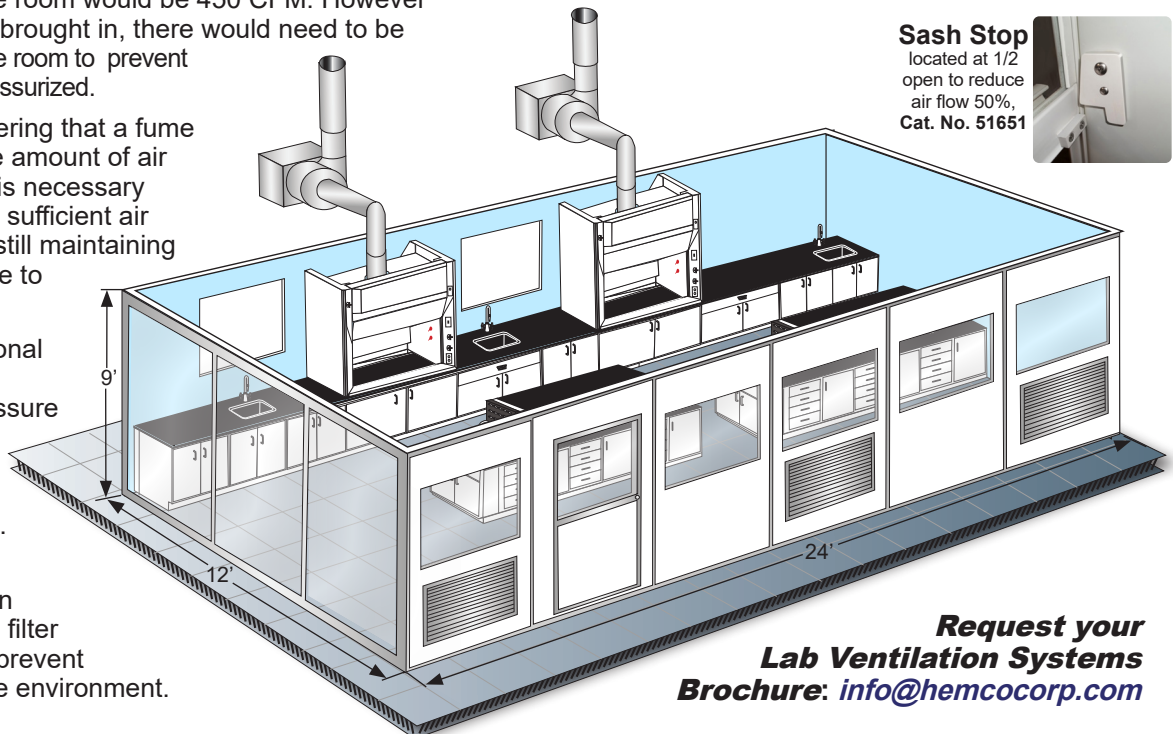

Sash Stop

located at 1/2 open to reduce air flow 50%, Cat. No. 51651

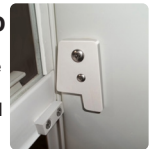

Request your Lab Ventilation Systems Brochure: info@hemcocorp.com

Fume Hood Ventilation and Duct Design

Ductwork connected to fume hoods may be arranged in a variety of patterns depending on requirements. Generally, the best exhaust system involves the shortest duct length and the fewest elbows. Duct size, length, and number of elbows affect static pressure loss and blower efficiency. Ideally, each fume hood should have its own ducting and blower to maximize hood flexibility and reduce danger of back draft from other hoods.

Common or manifold ductwork designs can be used, provided duct and blower have been sized properly. In these designs, individual hood dampers are recommended to balance the system. Hood users must be aware of how different hood exhaust fumes will react when mixed in the ductwork. Rigid PVC ductwork is recognized as an excellent fume hood exhaust duct material. The smooth interior surface reduces static pressure loss and chemical waste build up, and PVC is extremely resistant to a wide variety of reagents. For some applications flexible PVC lined duct provides adequate service and can significantly reduce installation costs. When planning exhaust ducting, duct size, length, number of bends, and exhaust material must be considered. Consult HEMCO for Lab Ventilation Solutions.

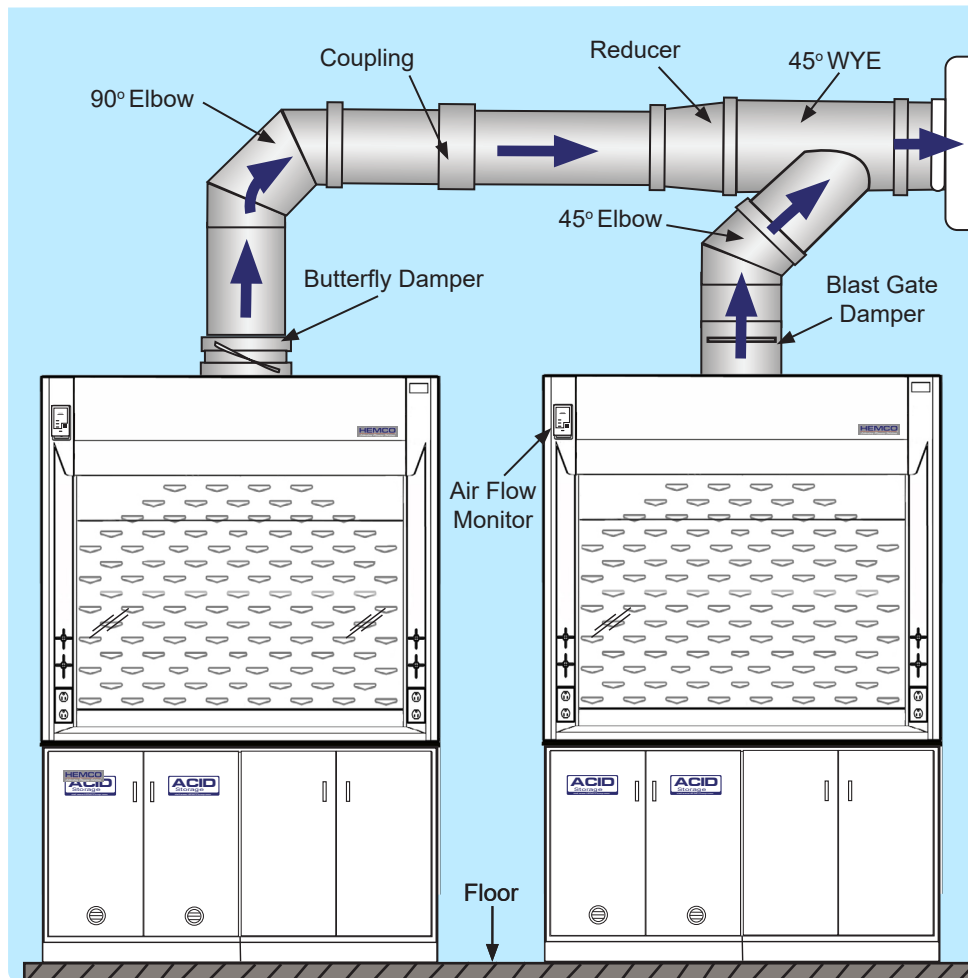
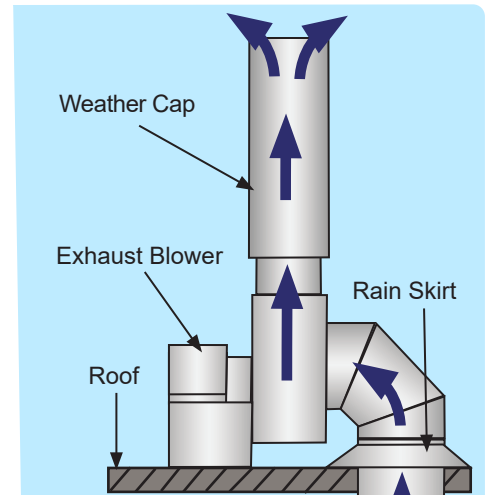

Hood Operation

- Consult Lab Safety Officer for correct use of fume hood.
- Hoods should not be used as laboratory storage space. Unnecessary material or unused bottles and flasks can block exhaust openings and interfere with hood performance.
- OSHA requires a fume hood be equipped with an Air Flow Monitor to track air flow velocities and warn operator of potentially dangerous low air flows due to damper, blower failure, blockage of ductwork system, or extreme sash opening height.

Air Flow Monitors Note: OSHA recommends air flow alarms to be installed on all fume hoods

Air Flow Monitor Analog



Continuously monitors face velocity air flow of fume hood. Select and calibrate at desired FPM velocity set point. If the hood face velocity falls below set point, an audible alarm sounds and a visual red indicator light appears. Air flow alarm is factory installed or can be field installed, 115/60Hz AC. Cat. No. 51403

Air Flow Monitor with Digital Display

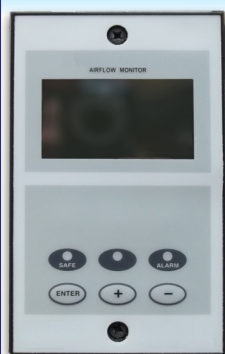

Continuously monitors face velocity air flow of fume hood. A digital display of face velocity in m/sec or FPM that indicates safety reading with an audible alarm. Push button calibration and 3 programmable input/output relays. Factory installed or can be field installed. Cat. No. 51410

Air Flow Monitor Intrinsically Safe



For applications where the fume chamber is classified but the surrounding lab space is not. Continuously monitors face velocity air flow of fume hood. If the hood face velocity falls below set point, an audible alarm sounds and a visual red indicator light appears. Factory installed or can be field installed. Cat. No. 51404

Canopy Hoods

Canopy hoods are designed to collect and exhaust corrosive vapors, heat, steam, and odors when mounted over areas with water baths, hot plates, or portable equipment. Standard color: Lab White

Wall Canopy Hoods (FRP or stainless steel, Includes wall mounting kit) (custom sizes available)

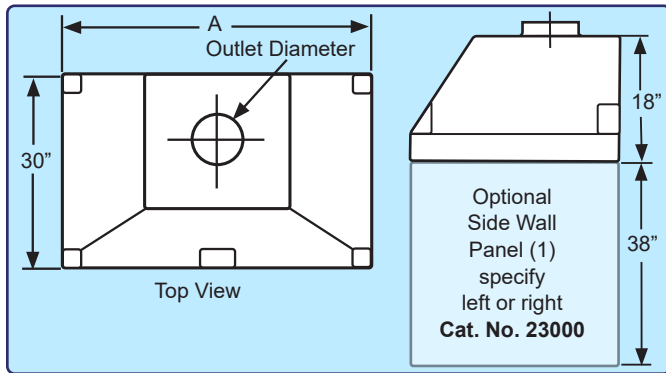

Side Wall Panel
(fiberglass or stainless steel)
kit includes one wall panel
and hardware.
Cat. No. 23000

Rear Wall Panel
(consult chart for Cat.No.)

**Vapor Proof Light
& Switch Cat. No. 50035**

**Blower Switch 115V/15A
Cat. No. 50028**

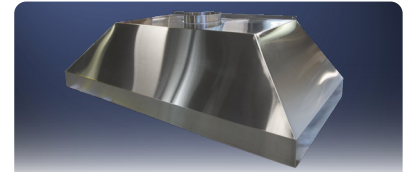

Type 304 stainless steel



Width A	36"	48"	72"	96"	Side Wall Panels
Fiberglass Cat. No.	13030	13040	13060	13080	23000
Fiberglass Rear Wall Panel	23016	23026	23036	23046	--
Stainless Steel Cat No.	13130	13140	13160	13180	23011
Stainless Steel Rear Wall Panel	23116	23126	23136	23146	--
Diameter D	6"	8"	10"	(2) 10"	--

Island Canopy Hoods (FRP or stainless steel) (custom sizes available)

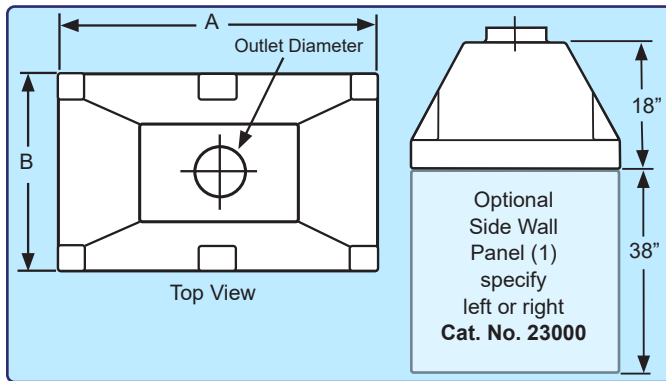

Suspended Island Canopy Hood Mounting Kit Includes all components to secure to ceiling including 6' long threaded rods.
Cat. No. 23001

Side Wall Panel
(fiberglass or stainless steel)
kit includes one wall panel
and hardware. **Cat. No. 23000**

Rear Wall Panel
(consult chart for Cat.No.)

**Vapor Proof Light
& Switch Cat. No. 50035**

**Blower Switch 115V/15A
Cat. No. 50028**

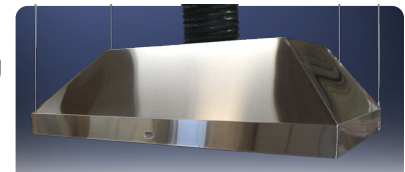

Type 304 stainless steel



Width A	36"	48"	72"	96"	Side Wall Panels
Fiberglass Cat. No.	23030	23040	23060	23080	23000
Fiberglass Rear Wall Panel	23016	23026	23036	23046	---
Stainless Steel Cat No.	23130	23140	23160	23180	23011
Stainless Steel Rear Wall Panel	23116	23126	23136	23146	---
Diameter D	6"	8"	10"	(2) 10"	---

Corner Canopy Hoods (FRP, Includes wall mounting kit)

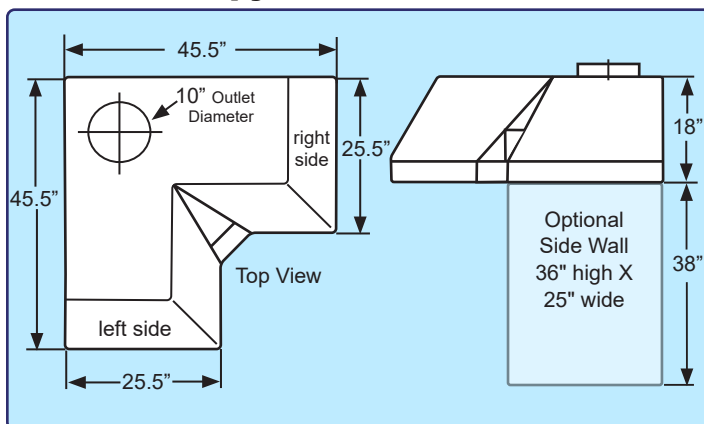

Side Wall Panels (fiberglass) 36" h X 25" w, kit includes one wall panel and hardware
Cat. No. 23006

Rear Wall Panels (2) required
Qty (1) 36" high X 45" wide
Cat. No. 23056

Vapor Proof Light & Switch Cat. No. 50035

**Blower Switch 115V/15A
Cat. No. 50028**

Corner Composite Resin Worksurface Gray, Comes dished to contain spillage.
Cat. No. 13503

Corner Table Features White welded steel construction. **Cat. No. 13502**



Corner Canopy (includes mounting kit, to install canopy to two adjacent walls) **Cat. No. 13000**

Laboratory Emergency / Shower Decontamination Booths

Full body emergency shower & eye / face wash, both with immediate response activation handle.

Durable one-piece seamless fiberglass construction with glass smooth white surfaces and covered corners for ease of clean-up.

Emergency showers available with translucent frosted strip curtains, which provides for easy access into booth, while containing contaminated water splash.

Stainless steel Grab bars located on right & left sides to support victim and rescue personnel during decontamination, included.

Plumbing is provided, for installation by local certified plumber. Plumbed to single point 1.25" IPT. connection. Tempered warm water supply connection 20 GPM water supply is required.

Raised fiberglass deck with self draining containment basin, and 2" diameter drain outlet located on either the bottom or rear of unit.

Industrial Applications
Emergency Drench Shower Booth
 unit is equipped with pull rod activated overhead drench shower and rear wall mounted eye/face wash.
Cat No. 16601

Laboratory Applications
Emergency Drench Shower Booth
 same specs as above except with finished exterior side panels.
Cat No. 16604



Cat. No. 16601
 For Industrial Applications
 shown above

Note: OSHA & ANSI require that emergency shower is to be located within 10 seconds walking time from the hazardous site location.



Overhead Drench Shower

Shower unit features 10" diameter plastic head and 1" IPS brass "stay open" valve with rigid pull rod and handle. **Cat. No. 16088**



Alarm Horn & Light
 Audible warning sound when system is activated by flow switch. Top mounted visual warning light when system is activated.
Cat. No. 16680



Eye/Face Wash

Wall mounting unit features two large plastic heads, push plate operated "stay open" ball valve. 1/2" IPS inlet, and 1.25" IPS drain. **Cat. No. 16006**

Eye and Face Wash Options



Hand Held Body Wash
 Squeeze valve nozzle on 8' coiled hose and bracket. Can be used to rinse all body parts while victim is sitting or lying down. Wall or hood mounted, 3/8 NPT, barrier free.

Cat No. 16005



Swing-Out Eye Wash

Deck mounted next to sink. Activates when pivoted. 1/2" NPT. Barrier free.

Cat. No. 16009



Hand Held Eye/Face & Body Wash

Mounted on the front side-wall of the fume hood. Includes 8' hose and surface escutcheon. 3/8" NPT. barrier free.

Cat. No. 93966



Create your Lab using
Plan-A-Lab by HEMCO



National Society of Professional Engineers



ASHRAE
 American Society of Heating Refrigeration and Air-Conditioning Engineers



Scientific Equipment and Furniture Association
 Founding Member



American Society of Mechanical Engineers



American Chemical Society
 Chemical Health & Safety



International Society of Pharmaceutical Engineers



UL Underwriters Laboratories
 Certified 1805 and 3101

Find our products with
ARCAT.com

Scan the Code to Visit
www.HEMCOcorp.com



Request a brochure of the following products:



UniFlow Laboratory Fume Hoods



UniMax Large Floor Mount Walk-In Fume Hoods



Laminar Flow HEPA Filtered Workstations



Modular Clean Labs



Laboratory Ventilation

HEMCO Corporation
 711 South Powell Road
 Independence, MO 64056

HEMCO

Laboratory Planning Solutions

www.HEMCOcorp.com
 LPSSL-06.24

Call: 816-796-2900

www.HEMCOcorp.com